

# INSTALLATION AND OPERATING INSTRUCTIONS



# CALMA 65x80/CALMA 80x50/CALMA 120x50

Manufacturer:

The owner of the Hitze brand is:  
STALKO Spółka z ograniczoną  
odpowiedzialnością sp. k.  
ul. Solec 24/253, 00-403 Warszawa

BIURO / MAGAZYN:  
ul. Gdyńska 32, 26-600 Radom  
Helpline: +48 800 880 030

The CALMA line of prestigious gas fireplaces was created and produced by the brand **HITZE**

*Keep these instructions together with the appliance. This document contains all the information necessary for the correct installation and use of the appliance described in it. The manual has a warranty card as well as installation and inspection reports. The installation and operation should be started after you have fully understood the content of the manual.*

# TABLE OF CONTENT

SAFETY RULES AND LAWS .....	4
APPLIANCE DESCRIPTION .....	6
GAS TYPES AND DESTINATION COUNTRIES .....	6
PARAMETERS AND SETTINGS.....	7
INSTALLATION GUIDE.....	9
APPLIANCE LOCATION .....	9
FLUE SYSTEM INSTALLATION .....	11
SETTING OF THE EXHAUST GAS FLOW LIMITERS .....	12
GAS INSTALLATION AND CONNECTION TO GAS VALVE.....	14
ELECTRICAL INSTALLATION.....	15
ARRANGEMENT OF DECORATIVE ELEMENTS.....	16
FIRST START-UP.....	17
APPLIANCE HOUSING REQUIREMENTS .....	17
CHANGING HEATER SETTINGS .....	18
CONTROL OF THE APPLIANCE.....	19
PAIRING OF THE REMOTE AND CONTROL VALVE.....	19
CONTROL USING THE MYFIRE APP (MAXITROL GAS CONTROL VALVE ONLY).....	20
CONTROL USING A SYMAX (MAXITROL) REMOTE CONTROL.....	20
CONTROL USING THE FB 868D REMOTE (TESC).....	25
ENVIRONMENT PROTECTION AND RECYCLING .....	28
ERROR CODES AND RESET ERRORS.....	28
SERVICE AND MAINTENANCE.....	29
TERMS OF WARRANTY .....	34
GAS HEATER INSTALLATION PROTOCOL .....	34
GAS HEATER INSPECTION PROTOCOL .....	35

*This manual is protected by copyright. All rights reserved. The manufacturer reserves the right to make corrections and changes to the manual without informing anyone about it.*

*The version of the manual should be verified with the version posted on [www.mycalma.pl](http://www.mycalma.pl)*

## ■ SAFETY RULES AND LAWS

### CAUTION

***The manual contains all the necessary information on the correct connection, start-up, construction and operation of CALMA series of gas appliances. Both installer and user of these appliances should read all the information contained in the manual. The manufacturer is not responsible for any damage or malfunction of the device caused by non-compliance with the guidelines contained in this manual.***

Installation, gas installation tightness control, inspection and maintenance may be performed only by a qualified person having appropriate authorizations applicable in a given country and region where the heater is installed. Connection to chimney ducts, wall and roof passages and all kinds of elements used to install the fireplace should be made in accordance with the applicable standards of construction law.

#### **The device installer / customer is responsible for:**

- Verifying of local gas distribution conditions.
- Verifying of heater settings.
- Checking of the completeness of the device and detecting any damage caused during the transport of the heater.
- Correct location of the heater.
- Preparation of the chimney system and connection of the heater to it.
- Connection to the gas installation, vent the gas system and first start of the heater.
- Checking the tightness of all connections included in the internal gas installation of the device and of all connections made.
- To acquaint the user with the basic functions of the fireplace and its operation.
- Completing the table with the type of gas and countries of destination.
- Filling in and signing the protocol from the installation of the device.

#### **The user (buyer) of the device is responsible for:**

- Obtaining information and to inform installer about the local gas distribution conditions.
- Execution / prepare of the gas connection in the place designated by the installer.
- Familiarize himself with the safety rules during the operation of the gas fireplace.
- Getting to know how to control of a gas fireplace.
- Keeping the instructions and documentation supplied with the fireplace.
- Ordering periodic inspections of both the installed device and the associated air-flue gas system
- Training in the use and safety rules of other potential users of the device.

### CAUTION

***Before installing, check the local distribution conditions (identify the type of gas and its pressure) and that the current setting of the heater is correct.***

All Hitze gas heaters have the **CE** marking and have been tested for compliance with **EN 613** Gas-fired convection space heaters by **KIWA Netherlands (NB0063)**. All gas appliances sold under the Hitze brand and the components used in them meets the

requirements of the **Regulation of the European Parliament and of the Council (EU) 2016/426 (GAR)** of March 19, 2016 and are approved for sale throughout the European Union. The heaters meet the requirements of the **directives 2014/35 / EU (LVD)** of February 26, 2014 and **2014/30 / EU (EMC)** of February 26, 2014.

The devices specified in this manual meet the requirements of **Commission Regulation (EU) 2015/1188 of April 28, 2015 on the implementation of Directive 2009/125 / EC of the European Parliament and of the Council (Ecodesign)**. All Hitze brand gas heaters have a seasonal energy efficiency greater than 72%, while their emission of nitrogen oxides calculated on the basis of GCV does not exceed 130 mg/kWh input limited by above Directive.

CALMA series of gas heaters have been adapted to work with a balanced flue system (concentric air-flue gas system), which means that the devices can be successfully used in homes with **recuperation**.

## C A U T I O N

***If you feel gas while operating the appliance, immediately turn off the fireplace, cut off the fuel supply to the device (shut off the main gas valve), disconnect the power supply to the electric circuit, ventilate the room and contact the service center.***

**PLEASE READ THE FOLLOWING SAFETY INFORMATION CAREFULLY AS FAILURE TO OBSERVE IT MAY RESULT IN SERIOUS INJURY OR EVEN DEATH:**

- Any modification or alterations beyond those specified in the manual are strictly prohibited.
- The appliance works only with the gas to which it has been factory-adapted.
- Heaters working with propane gas or propane-butane gas mixture (gases heavier than air) cannot be installed in rooms where the floor is below ground level.
- In the event of a malfunction of the device, cut off the gas supply (shut off the gas valve), disconnect the power supply and contact the service center.
- Children and other unaware people, infirm people and other people requiring special attention should remain under special supervision while using the heater.
- All elements of the appliance along with its glazing are working surfaces. It is forbidden to touch the working appliance as it heats up to high temperatures. The appliance is operated with a wireless remote control or a dedicated mobile application.
- The appliance cannot be put into operation without the glass / glasses installed. If the glazing is damaged in any way, it must be replaced immediately before you will start the appliance again.
- Automation (Gas Control Valve) components should not be exposed to moisture and dust.
- When servicing the appliance, use only materials and components provided by the manufacturer.
- Only decorative elements supplied by the manufacturer can be installed in the appliance. The way of assembling the elements is presented in this manual.
- The ceramic logs used in the appliance are elements of the gas burner. It is forbidden to modify the arrangement of those logs.
- There must be no flammable materials in the vicinity of the working appliance.
- Curtains and other flammable materials must not be placed directly above the appliance and at a distance of at least 2 m.
- If the control flame goes out during operation which will lead to stop the appliance, wait at least 10 minutes before re-starting it.
- If, during the first start-up, the appliance does not turn on after 5 attempts, wait 5 minutes before carrying out the next ignition procedure.
- If the heater will not be used for a long time, the gas supply should be cut off (shut off the gas valve).

## APPLIANCE DESCRIPTION

CALMA series gas heaters are modern appliances that can work with G20 (high-methane natural gas), G27 (nitrogen-rich natural gas), G30 (propane-butane gas mixture) or G31 (propane gas) gas. The heaters are operated remotely with a remote control or with the use of a dedicated application installed on mobile devices equipped with Android or iOS (optional). The gas installation in CALMA series fireplaces is complete and requires only gas connection from the installer.

The heaters are adapted to work with a balanced flue (concentric pipe flue) system based on two coaxial pipes with a circular cross-section, from which the external one supplies air to the combustion chamber, and the internal one is responsible for exhaust gas discharge.

The body of the appliance is made of high-quality 3 mm thick boiler plate. The rear and side walls of the combustion chamber may be lined with elements made of steel, decorative glass or elements made of accumulative material.

The appliance is equipped with anti-explosion flaps and anti-outflow protection, which makes them completely safe, even in the event of unforeseen random events.

## GAS TYPES AND DESTINATION COUNTRIES

Model name				Appliance category		Gas pressure and type		Destination countries	
CALMA 65x80	<input type="checkbox"/>	S	<input type="checkbox"/>	2E	<input type="checkbox"/>	20 mbar, G20	<input type="checkbox"/>	A	
CALMA 80x50	<input type="checkbox"/>	L	<input type="checkbox"/>	2H	<input type="checkbox"/>	20 mbar, G20	<input type="checkbox"/>	B	
CALMA 120x50	<input type="checkbox"/>	R	<input type="checkbox"/>	2Lw	<input type="checkbox"/>	20 mbar, G27	<input type="checkbox"/>	C	
		D	<input type="checkbox"/>	3B/P	<input type="checkbox"/>	30 mbar, G30	<input type="checkbox"/>	D	
		TC	<input type="checkbox"/>	3P	<input type="checkbox"/>	37 mbar, G30	<input type="checkbox"/>	E	
		TU	<input type="checkbox"/>			50 mbar, G30	<input type="checkbox"/>	F	
						30 mbar, G31	<input type="checkbox"/>	G	
						37 mbar, G31	<input type="checkbox"/>	H	

Model of the Gas Valve the appliance is equipped with

<input type="checkbox"/>	MAXITROL	<input type="checkbox"/>	TESC	<input type="checkbox"/>
--------------------------	----------	--------------------------	------	--------------------------

<b>A</b>	DE, PL, RO
<b>B</b>	AT, CH, CY, CZ, DK, DE, EE, ES, FI, GB, GR, HR, IE, IT, LT, LU, LV, NO, PT, RO, SE, SI, SK, T
<b>C</b>	PL
<b>D</b>	BE, CY, DK, EE, FR, GB, GR, HU, HR, IT, LT, NL, NO, RO, SE, SI, SK, TR
<b>E</b>	PL
<b>F</b>	AT, CH, DE, SK
<b>G</b>	FI, NL, RO
<b>H</b>	BE, CH, CZ, ES, FR, GB, GR, HR, IE, IT, LT, NL, PL, PT, SI, SK

# PARAMETERS AND SETTINGS

## CALMA 65x80

Parameter	Unit	Reference gas			
		G20	G27	G30	G31
Pp	mbar	20	20	29/37/50	29/37/50
P reg Qn	mbar	10,1	15,4	13,1	16,4
P reg Qm	mbar	3,7	5,6	5,4	6,8
Qn/Qm	kW	13,1/7,9	12,7/7,4	13,8/8,7	13,4/8,5
V Pn/V Pm	m3/h	1,371/0,831	1,618/0,946	0,423/0,268	0,543/0,342
$\eta$	%	86,8	86,8	87,3	87,4
EEl	-	86,3	86,3	87,1	87,2
Klasa NOx*	-	4	4	5	5
Waga**	kg	161	161	161	161

\* emission level of nitrogen oxides according to EN 613

\*\* S version

## CALMA 80x50

Parametr	Unit	Reference gas			
		G20	G27	G30	G31
Pp	mbar	20	20	29/37/50	29/37/50
P reg Qn	mbar	6,4	9,9	7,9	9,5
P reg Qm	mbar	2,7	4,2	5,5	6,8
Qn/Qm	kW	10,8/7,2	10,3/6,7	10,7/8,8	10,2/8,5
V Pn/V Pm	m3/h	1,142/0,758	1,330/0,868	0,326/0,270	0,411/0,344
$\eta$	%	86,0	86,0	84,1	82,3
EEl	-	85,4	85,4	83,8	82
Klasa NOx*	-	5	5	5	5
Waga**	kg	152	152	152	152

\* emission level of nitrogen oxides according to EN 613

\*\* S version

## CALMA 120x50

Parameter	Unit	Reference gas			
		G20	G27	G30	G31
Pp	mbar	20	20	29/37/50	29/37/50
P reg Qn	mbar	5,8	9,4	16,5	20,5
P reg Qm	mbar	2,4	4,4	7,8	9,8
Qn/Qm	kW	16,7/10,6	16,7/10,8	17,6/11,9	17,4/11,6
V Pn/V Pm	m <sup>3</sup> /h	1,753/1,111	2,144/1,386	0,538/0,363	0,698/0,468
η	%	84,0	84,0	86,8	85,1
EEl	-	83,6	83,6	86,6	84,9
Klasa NOx*	-	5	5	5	5
Waga**	kg	205	205	205	205

\* emission level of nitrogen oxides according to EN 613

\*\* S version

**Pp** - nominal connection pressure

**P reg Qn** - pressure behind the regulator for nominal power input

**P reg Qm** - pressure behind the regulator for minimum power input

**Qn** - nominal power input according to Hi

**Qm** - minimum power input according to Hi

**V Pn** - gas consumption stream for nominal power input

**V Pm** - gas consumption stream for minimum power input

**η** - appliance efficiency

**EEl** - Energy Efficiency Index

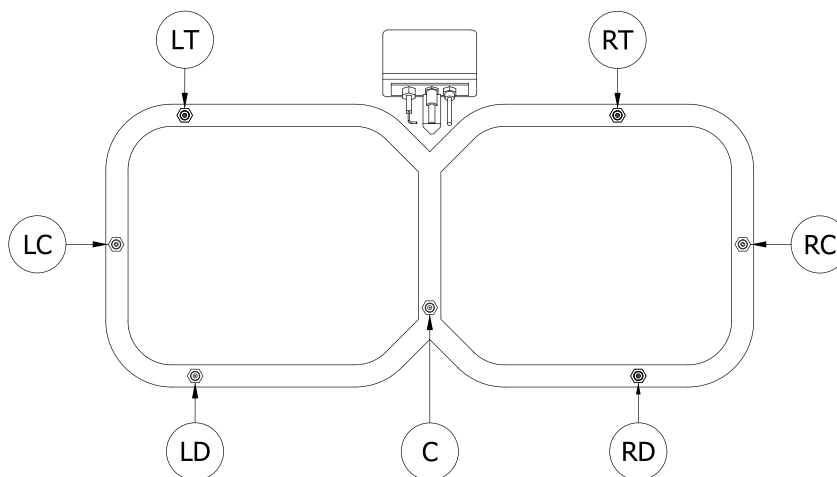

Fig.1. Marking of the position of injectors in the gas distributor in CALMA series heaters



Appliance	Marking and position of the injector in the dispenser						
	LT	LC	LD	C	T R	RC	RD
CALMA 65x80 - G20/G27	22	brak	21	1	2	brak	19
CALMA 65x80 - G30/G31	13	brak	13	1	12	brak	11
CALMA 80x50 - G20/G27	24	brak	24	1	21	brak	21
CALMA 80x50 - G30/G31	13	brak	13	1	12	brak	11
CALMA 120x50 - G20/G27	22	22	2	1	2	22	2
CALMA 120x50 - G30/G31	12	12	1	1	1	12	1

## ■ INSTALLATION GUIDE

### CAUTION

***Installation of the gas heater may only be carried out by a qualified person with appropriate entitlements. Connection to the gas installation, chimney ducts, wall and roof passages, and all kinds of elements used to install the fireplace should be made in accordance with the construction law standards in force in the country and region where the heater is installed.***

## ■ APPLIANCE LOCATION

CALMA series gas heaters should be installed on a stable, non-flammable surface with the required load-bearing capacity. The device should be placed at least 1.2 meters from flammable materials. The seat of the heater should ensure the minimum number of elbows of the balanced flue system (concentric system) cooperating with it and ensure the simplest possible routing of the gas supply pipe.

The fireplace should be located at least 50 mm from non-flammable walls. The increase in temperature of the walls exposed to the direct impact of the fireplace should not exceed the ambient temperature by more than 80 ° C.

The appliance has a two-stage height adjustment system. The heater is equipped with adjustable legs, which additionally have feet with smooth height adjustment in the range of 0-25 mm. The use of feet allows for trouble-free leveling of the insert. The adjustment legs are mounted to the heater body with 4 bolts and M8 nuts. In the event of complete disassembly of the adjustment legs, the feet should be disassembled and screwed into the dedicated holes in the heater legs. After leveling the heater, the feet should be locked by tightening the counter screw towards the body. The use of additional legs allows the heater to be raised by a maximum of 150 mm.

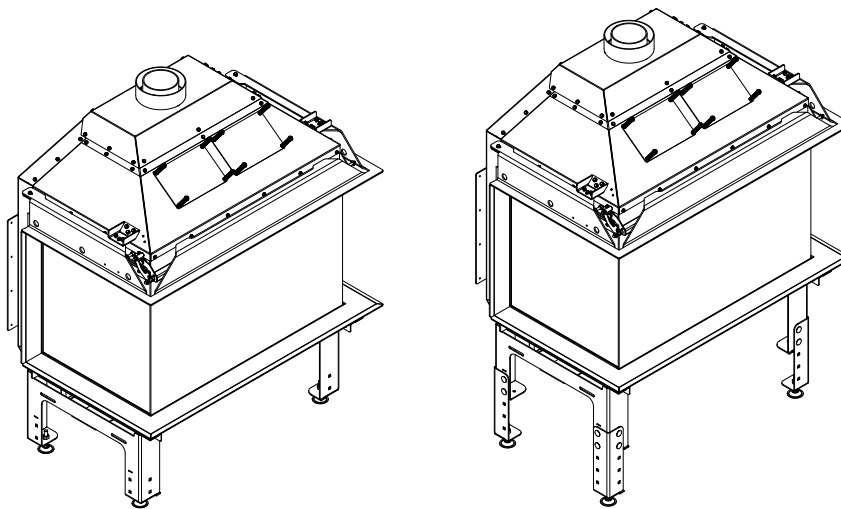

Fig. 2. Gas heater - minimum and maximum height

CALMA series appliances are also suitable for wall mounting. To make this possible, the installer should verify that the mounting wall has adequate load-bearing capacity. Installation on the wall requires the use of dedicated fasteners offered by the manufacturer. If the heater is mounted on the wall, the manufacturer allows the heater legs to be shortened.

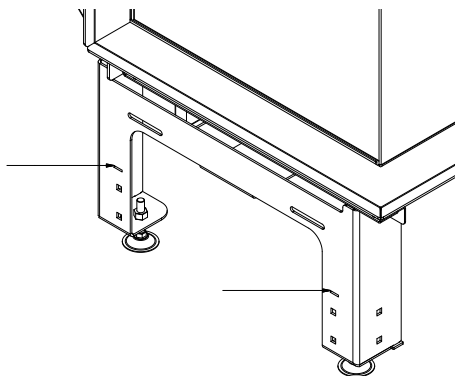

Fig. 3. Holes marking the cutting line when installing the heater on a Wall

### CAUTION

***Gas heaters that work with gases heavier than air cannot be installed in rooms where the floor is located below the ground level, and in rooms with ventilation ducts, the end of which is in a place where gas can accumulate without the possibility of its discharge.***

## ■ FLUE SYSTEM INSTALLATION

CALMA series gas heaters have been adapted to work with POUJOLAT balanced flue (concentric air-flue) gas systems, BI-GAS and DUO-GAS models in sizes 150/100 (CALMA 65, CALMA 80) and 200/130 (CALMA 120). These systems work under negative pressure, which eliminates the need for additional seals. Individual elements are connected with each other using a dedicated clamp.

The system is made of acid-resistant steel and can be used in solutions where the exhaust gas temperature in the heater does not exceed 600 ° C. The systems can be purchased directly at the device manufacturer of the fireplaces, in online stores or in local stores listed at [www.poujolat.pl](http://www.poujolat.pl). The flue systems used in Hitze gas appliances can be led out through the side wall of the building (**C11 type system**), through the roof (**C31 type system**), or use the existing chimney (**C91 type**).

Connection to the flue system, system routing, distances from combustible materials, roof and wall passages, sealing and insulation should be made in accordance with the relevant regulations in force in the country or region where the appliance is installed. During designing of the flue system, all difficulties related to the wind pressure on the terminal should be taken into account.

### **The flue lead through the wall - type C11.**

In this type of solution, the flue system should be started with an element with a minimum length of 1 meter. When leading the flue through the side wall, only one 90 ° bend can be used, and the length of the horizontal section must not exceed 3 meters. Termination of the coaxial system should be performed using a dedicated horizontal terminal. In order not to disturb the air flow, the horizontal section should be level.

### **Flue system lead through the roof - type C31.**

The recommended length of the flue led out through the roof is a maximum of 12 meters and depends on the number of elbows used. It is assumed that the use of a 45 ° elbow reduces the permissible length of the flue system installed by 1 meter, and the use of a 90 ° elbow - by 2 meters. Each horizontal section is treated as 2 meters. If the flue system is routed in the C31 system, it is permissible to use the first vertical section with a length of 0.5 to 1 meter. Vertical terminal should be used at the end of the flue system.

### **Leaving the flue using the existing chimney - type C91.**

In this solution, the flue system is led out vertically, as in the case of C31. A vertical section with a length of 0.5 to 1 meter is mounted on the heater, and then, using a 45 ° or 90 ° elbow and a single straight element of a flue system is introduced into the existing chimney. Then only the internal flue gas discharge pipe runs through the entire length of the existing chimney. At the end of the chimney, reuse the concentric element in the form of a vertical terminal. The connection between the chimney and the concentric system should be tightened on both sides of the installation. The chimney used in the installation must be clean, tight and unobstructed. The minimum diameter of the existing chimney used is 150 mm for the 150/100 system and 200 mm for the 200/130 system. In the case of chimneys with a rectangular cross-section, their cross-flow area must not be less than 225 cm<sup>2</sup> for the 150/100 system and 400 cm<sup>2</sup> for the 200/130 system. The recommended maximum length of the concentric system section run inside the existing chimney is 7 meters.

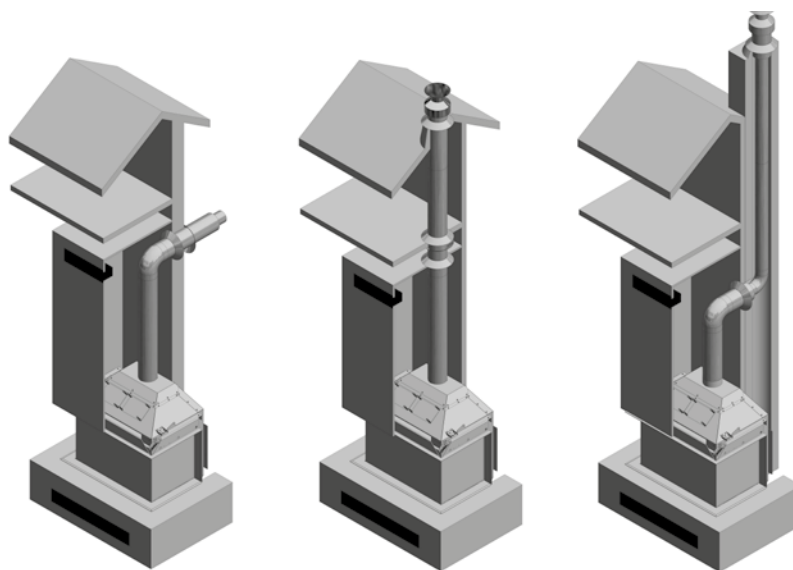

Fig. 4. Basic variants of the air-flue gas system admitted with heaters from the CALMA series (from the left, type C11, C31, C91)

## ■ SETTING OF THE EXHAUST GAS FLOW LIMITERS

Gas heaters from the CALMA series have been adapted to work with the largest possible configuration of flue systems, therefore, in the design of their deflectors, adjustable shutters were used, the flow cross-section of which is adapted to the method of conducting the air-flue gas system.

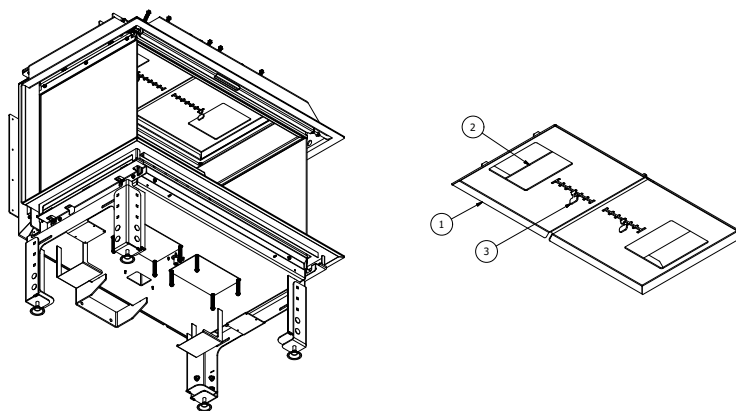

Fig. 5. Deflector assembly: 1 - deflector; 2 - shutter; 3 - shutter handle

The size of the opening of the shutter is regulated by a handle located below the deflector. The adjustment handle has been designed in such a way that in order to adjust the shutter settings, it must first be lifted up and then set to the desired position. The position of the barrier is locked by lowering its handle to its lower position. Depending on the type and length of the flue system used, the shutters in the deflectors should be set in the positions specified in the table below.

**When calculating the length of the chimney system, each 45 ° bend should be taken as 1 m and 90 ° as 2 m. In the C31 system, each horizontal section is taken as 2 meters in the calculation.**

	The length of the flue system without the terminal [m] *													
	1	2	3	4	5	6	7	8	9	10	11	12	13	14
System type	The position of the shutter holder in the deflector depending on the length of the air-flue gas system													
C11	-	-	5	6	7	7	-	-	-	-	-	-	-	-
C31	-	-	4	3	2	1	1	1	1	1	2	2	-	-
C31 - 45°	-	-	-	-	7	7	1	1	1	1	1	2	2	3
C31 - 90°	-	-	-	-	-	-	-	7	7	1	1	1	2	2
C91 - 45°	-	-	-	-	7	7	1	1	1	1	1	2	2	3
C91 - 90°	-	-	-	-	-	-	-	7	7	1	1	1	2	2

\* the installation must provide a chimney draft of at least 6 Pa

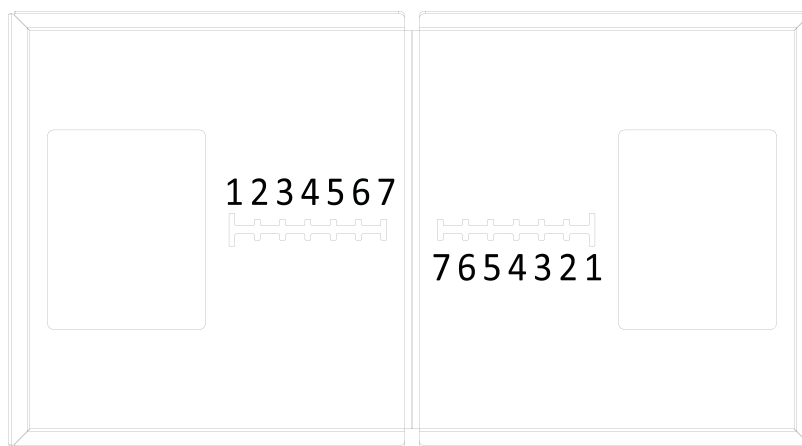

Fig. 6. Marking the position of the shutters holders in the deflector assembly (1 - fully closed, 7 - fully open)

## ■ GAS INSTALLATION AND CONNECTION TO GAS VALVE

CALMA series gas heaters are factory-adjusted to work with a given type of gas and under a specific pressure. Gas equipment and pressure settings are set by the manufacturer and it is forbidden to make any modifications. **The appliance works only with the gas to which it has been factory-adapted.** All the necessary information on the heater settings can be found on the appliance's rating plate. **Connecting gas with a pressure higher than 50 mbar to the device will damage its automatics.**

### CAUTION

***Make sure there is the correct gas and pressure in the gas installation. No open flames are allowed when installing gas space heaters. All installation and service work should be performed with the gas supply shut off and the power source disconnected. It is forbidden to make any changes to the design of the appliance. It is strictly forbidden to lengthen / shorten the gas lines, magneto cable and thermocouple. All unused connections in the gas installation should be tightly closed. It is forbidden to use the screws in the controller housing. Failure to follow the guidelines could result in an explosion, fire, damage to health, and even death.***

Appliances manufactured under the Hitze brand are equipped with high-class gas automatics. The applied automation meets the requirements of the GAR 2016/426 regulation and is designed to work with gases of the 2nd and 3rd family according to EN 437: 2003 + A1: 2009 and the subject standard EN 613: 2002 + A1: 2004. The gas installation, the heaters are equipped with is complete and only requires the installer to connect the fireplace to the gas supply. Connecting the main gas inlet requires a gas connection that is as close as possible to the device to be installed. The connection should be equipped with a gas filter and a manual shut-off valve. Gas should be supplied to the unit using a flexible hose with 1/2 inch female thread. The hose used should be free from contamination and should have appropriate markings allowing it to work with appropriate gaseous fuels. The connection should be sealed with the use of a dedicated gasket supplied with the conduit, or hemp with sealing paste.

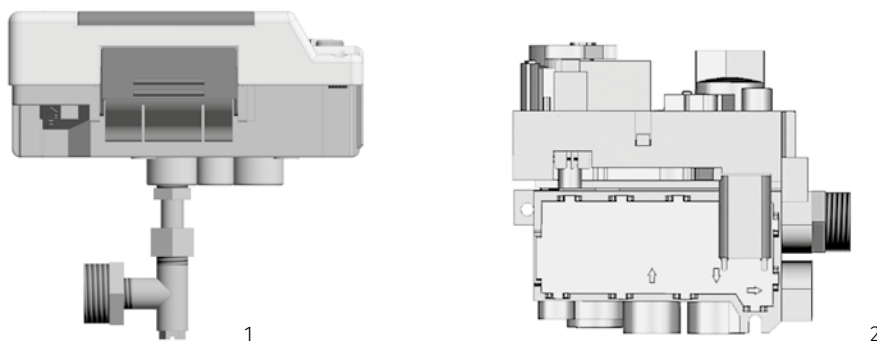

Rys. 7. Umiejscowienie przyłącza gazowego: 1 - TESC; 2 - MAXITROL

The CALMA series appliances, depending on the control method, can be equipped with one of two types of automation / gas control valves. The location of the controller and cooperating components can be modified depending on the needs.

**Gas automation components installed outside the heater's body must not be exposed to temperatures higher than 50 ° C.**

## ■ ELECTRICAL INSTALLATION

### CAUTION

***The power supply can be connected only after connecting the device to the air-flue gas system and after connecting the gas. It is forbidden to make any modifications to the electrical system. When replacing, use only alkaline batteries.***

The electrical installation used in the CALMA series heaters is complete and requires the installer to connect the power source only and connect it to the gas valve. Regardless of the automation used in your appliance, you must install the appropriate batteries in your remote control and the module responsible for controlling the fireplace:

- Control with the use of MAXITROL automation
  - Remote - 2 batteries 1,5 V type AAA
  - Control Module - 4 batteries 1,5 V type AA
- Control with the use of TESC automation
  - Remote - 2 batteries 1,5 V type AA
  - Control Module - 3 batteries 1,5 V type AA

Replacing the batteries in the devices does not require re-synchronization of the remote control with the control module. The batteries should be placed in the devices following the markings marked in the place of their installation. New batteries should last for one heating season. Batteries should be replaced at least once a year. It is forbidden to use batteries of different types and those that have been exposed to moisture or high temperature. Instruments that can cause a short circuit must not be used when changing the battery. It is forbidden to start the heater without the battery cover installed in both the remote control and the control module. Remove the batteries if the appliance will not be used for a long period of time.

Regarding the version of the heater with WiFi module (mobile myfire App control), the control module with batteries should be connected to the 6V DC / 1A power adapter supplied with the appliance, otherwise the batteries in the receiver will be discharged within 24 hours.

All devices indicate the need to replace the battery. Short cyclical signals when trying to fire up a heater equipped with the MAXITROL automatics inform about the need to replace the battery in the receiver. There are appropriate icons on the remote controls showing the degree of their discharge. In the remotes cooperating with the TESC automatics, the symbols „RC” and „FC” are displayed alternately by the battery indicator. “RC” shows how much charge is in the remote control's batteries, and “FC” shows how much power is left in the control module's batteries. If the battery in the control module is completely discharged, random error codes may appear on the display.

## ■ ARRANGEMENT OF DECORATIVE ELEMENTS

CALMA series gas heaters come complete with a dedicated set of ceramic logs. Logs are an integral part of the burner, so it is very important to arrange them correctly. The elements installed on the profiles have a recess at the bottom, which facilitates the assembly of logs. In the heater's combustion chamber, it is allowed to use additional decorative materials provided by the manufacturer and available in his current sales offer. The logs are arranged according to the diagram below.

Ceramic elements of the burner lining:

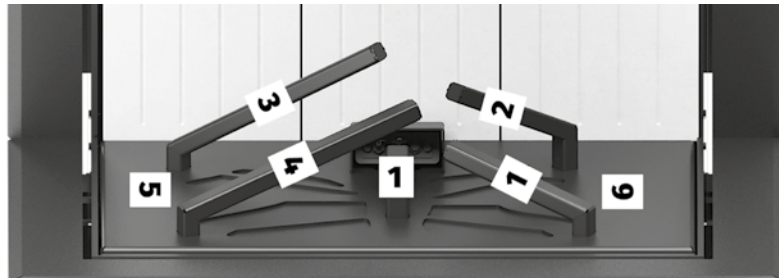

Fig. 8a. Arrangement of decorative elements CALMA 65x80 and CALMA 80x50

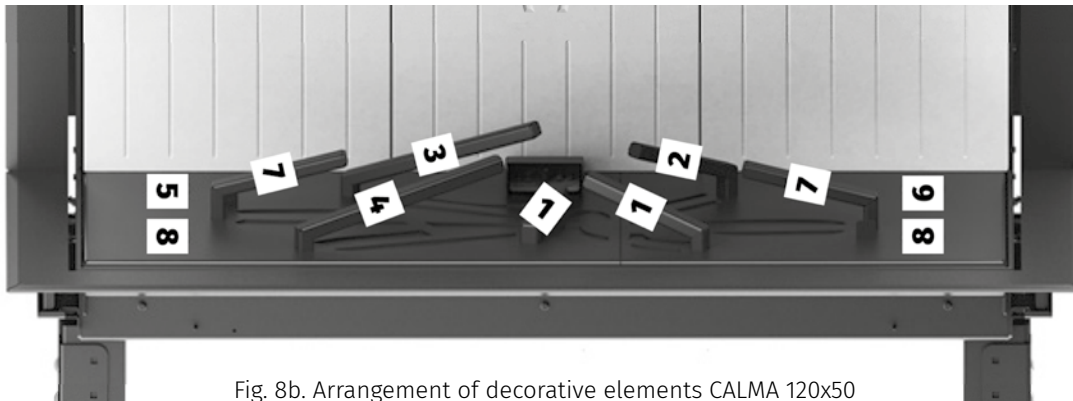

Fig. 8b. Arrangement of decorative elements CALMA 120x50



## C A U T I O N

***It is forbidden to use the device without the dedicated ceramic logs installed. Logs are elements of a gas burner. Lack of logs when lighting the device causes incorrect ignition and incorrect flame transmission!***

### ■ FIRST START-UP

Ogrzewacz można uruchomić dopiero po podłączeniu instalacji kominowej, gazu, oraz po instalacji ceramicznych polan i innych dekoracyjnych materiałów. The heater can be started only after connecting the flue system, to the gas source and after installing ceramic logs and other decorative materials. The first start-up should be performed with the front glass disassembled and the shutters in the deflectors fully open (the handle of the shutter in position 7). The gas installation of the heater should be deaerated several times by carrying out the ignition procedure. An unsuccessful firing-up procedure will display an error on the remote control that must be reset. In the case of devices equipped with TESC automatics, if there is no flame on the control burner during ignition, the procedure will be repeated automatically two more times.

After starting the ignition procedure, the control module will cyclically generate a spark on the control burner. After venting the gas installation, a flame will appear on the control burner. The control burner flame will then heat the thermocouple, which will open the gas supply valve to the main burner. During the first start-up, the installer is obliged to check the tightness of the gas installation of the heater and the tightness of the connection made. After checking the tightness of the gas installation, shut off the fireplace, wait until the heated elements of the device reach the ambient temperature, then set the shutters in the deflectors in accordance with the recommendations contained in this manual and install the front glass.

Then start the heater and make sure that it works properly. The procedure of extinguishing and restarting the heater, increasing and reducing the flame of the main burner should be carried out one after another. **The flame of the main burner will reach the optimal color and height after the appliance is completely heated up.**

During the first few hours of burning, smoke may come out of the body of the appliance with a characteristic smell. It is related to the phenomenon of the final hardening of the paint. The first burning in the heater should be carried out in a well-ventilated room.

### ■ APPLIANCE HOUSING REQUIREMENTS

## C A U T I O N

***The housing should be made only after the gas heater is connected and tested. Installation should be made in accordance with the provisions of the construction law in force at the place of installation of the appliance. The housing must have inspection openings necessary to service the heater. During building of the housing construction, the external elements of the heater's automatics should be protected against contamination.***

The housing of the CALMA series gas heater must be made of non-flammable materials and should be a self-supporting structure. No part of the casing may be connected to the elements of the gas heater. The construction of the housing must enable its disassembly without the possibility of damaging the heater installed in it.

The walls of the housing should be away from the heater in such a way as to allow free air flow along its body. In the housing, holes should be provided in which grates necessary for proper air circulation will be installed.

The grates fixing system should ensure their trouble-free disassembly. In the event of improper ventilation of the housing, the automation components with which the heater is equipped will be exposed to overheating, which poses a threat to the user and may cause incorrect operation of the appliance. The control devices used in the CALMA series gas heaters cannot be exposed to temperatures higher than 50 ° C. When selecting an inlet ventilation grate, it should be assumed that the area of its flow area cannot be smaller than 50 cm<sup>2</sup> for each 1 kW of the heater's power. For the outlet grates, it is assumed to be 60 cm<sup>2</sup> for every 1 kW. The openings for the ventilation grates should be placed in such a place that after removing the grates, they can be used as an access inspection for servicing the appliance (leakage check, battery replacement). It is a good practice to make the lower part of the housing without any connections, so that it can be completely disassembled (slide off).

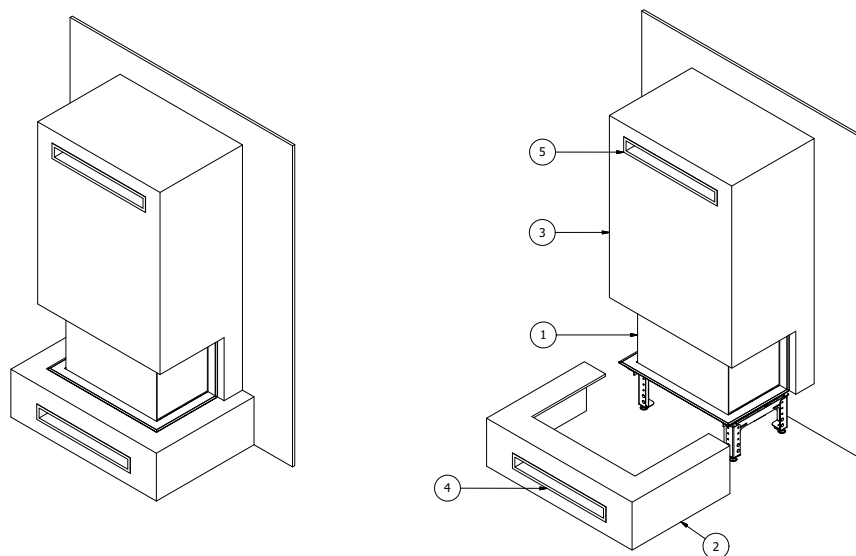

Fig.9. Diagram of an exemplary housing: 1 - heater; 2 - lower part of housing; 3 - upper part of housing; 4 - bottom ventilation grates; 5 - upper ventilation grates

## ■ CHANGING HEATER SETTINGS

The manufacturer allows the heater to be adapted to work with a gas other than the gas specified on the label. **Changing the appliance settings is payable and can only be performed by the manufacturer's authorized service.** After the activities, the service prepares an appropriate report in two copies for each party. The end user receives a new rating label from the manufacturer, which he places on the device in place of the previous one.

## ■ CONTROL OF THE APPLIANCE

### CAUTION



*It is forbidden to manually change the position of the knobs on the controllers. The fireplace is controlled automatically. If the control flame will shut down during the ignition attempt, wait at least 5 minutes before the next attempt. If the flame on the control burner does not appear after four consecutive tests in a row, cut off the gas supply to the device and contact the service. This procedure already applies to previously vented appliances. After the hot device is extinguished, wait at least 5 minutes before lighting it up again.*

CALMA series gas heaters can be operated with the use of two different types of automation: TESC or MAXITROL. The appliances can be controlled by a wireless remote control (TESC or MAXITROL) or a dedicated application installed on mobile devices equipped with Android or iOS (MAXITROL). Depending on the selected variant, the user receives a SYMAX or FB 868D remote control in the set. **In both cases, the remote control acts as a thermometer and is used in thermostat mode, therefore it should be kept in a dark place to avoid errors related to sunlight.**

## ■ PAIRING OF THE REMOTE AND CONTROL VALVE

The supplied remote control is already paired with the appliance's control valve at the factory. If the automation does not respond to commands given by the remote control, make sure that the batteries in the remote control and the control module are not discharged. In the case of replacement of the batteries in the remote, it is not required to enter a new transmission code. When pairing, the remote control should be as close to the control box as possible (no further than 1 meter).

**SYMAX (MAXITROL)** - Press and hold the **RESET** button on the receiver until you hear two beeps. Then release the button and on the paired remote control press and the button responsible for reducing the flame height. A message will appear on the display to inform you that pairing has started. Two short signals confirm the correct synchronization of the remote control with the receiver.

**FB 868D (TESC)** - Unlock the remote control and make sure the switch on the heater control module is in the **ON** (I) position. Press the  $\oplus$  and  $\ominus$  buttons on the module simultaneously. The red lamp on the module should start blinking rapidly. Release the buttons and press the On / Off button below within one second. If the above steps have been carried out correctly, the remote will confirm it with an acoustic signal, the green light will start flashing on the remote control and the  symbol will appear on its display. To accept the pairing, press and hold the **SET** button for a few seconds. Confirmation of correct synchronization of the remote control with the control module is a sound signal and appearance of  on the display. Then, unlock the remote control and configure it. Pressing the SET button takes you to further settings, and pressing the MODE button returns to the previous option. To change the settings in a given option, use the  $\oplus$  and  $\ominus$  buttons. After setting the time, temperature unit and display backlight, complete the setup by pressing and holding **SET** button. **Do not redo the pairing procedure if the remote control has been correctly synchronized before.**

In the case of TESC automation, to reset the connection between the remote control and the control module, you must unlock the remote control and enter the **SETUP** menu. Then press **SET** to move to the "CA0" setting. Changing the parameter value to "CA1" and confirming it with the **SET** button will reset the connection between the remote control and the control module.

## ■ CONTROL USING THE MYFIRE APP (MAXITROL GAS CONTROL VALVE ONLY)

### CAUTION

***Before you will start installing the application on your mobile device, first connect it to the network to which the fireplace will be connected. The device on which the application and the gas heater are installed must be connected to the same wireless network.***

Hitze gas heaters can be adjusted to be controlled via a dedicated myfire App designed to be installed on mobile devices. In order for the gas heater to be controlled via the application, the user must have:

- Device with Android (version 5.0 or later) or iOS (version 10.0 or later).
- Compatible wireless router with internet access.

More detailed information and video instructions are available at [www.myfireapp.com](http://www.myfireapp.com). Myfire App should be downloaded from the Apple App Store or Google Play Store, and then by clicking on its icon, proceed to configuration. First select the language, the temperature unit (° C or ° F) and the time format (12 or 24 hours). Then proceed to a one-time registration:

- Touch the application window anywhere. Enter the data, accept the „Privacy Policy“ and press the „Register“ button.
- Touch the „OK“ button in the displayed message. You will be asked to confirm your registration. Login to the e-mail address you provided during registration and confirm it by clicking on the link in the message from myfire App. You will be informed that your registration was successful. Go to the myfire App.

Then log in to the application using the e-mail and password provided during the registration procedure, accept the „Terms and conditions of use of the application“ and press the „Register“ button. Then:

- Connect the device on which the application is installed with the module in the gas heater. Press the button „Connect new myfire Wi-Fi box“. The device will automatically connect to the wireless module of the heater. If the application asks for the password for the Wi-Fi box, enter „MYFIREPLACE“.
- Then connect the Wi-Fi box to your home network. Select the name of your home network and enter a password, if applicable. Press the „Connect“ button.
- Configure the gas heater settings. Enter its name, assign an icon, activate the available functions, set the date and time and confirm by pressing „Finish“. The application will display a window confirming connection of the module with the application. To start using the myfire App, press „Start APP“.

## ■ CONTROL USING A SYMAX (MAXITROL) REMOTE CONTROL

In gas heaters adapted to work with the myfire App, the user receives a Symax remote control in the set. The device can also be used to directly control the fireplace. If the gas heater is controlled via the myFire App and the thermostat, programmable or ECO mode is activated in the app, the **“APP”** symbol will appear on the remote control display in the hours and minutes field.

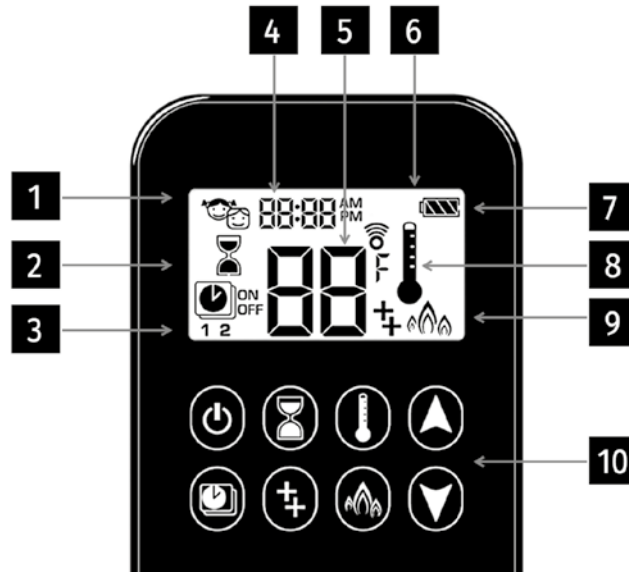
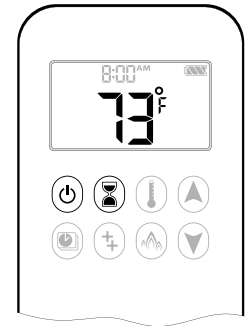

Fig. 10. SYMAX (MAXITROL) remote control: 1 - Child Proof, 2 - Timer mode, 3 - Program mode, 4 - Hour and minute field, 5 - Ambient temperature, 6 - Display, 7 - Battery indicator, 8 - Thermostat mode , 9 - ECO Mode, 10 - Buttons

## ■ SETTING THE TEMPERATURE UNIT

To change the displayed temperature unit, press and simultaneously. The user can choose between degrees Celsius and degrees Fahrenheit. Choosing °F will automatically set the clock in 12 hour format, while choosing °C will set the clock in 24 hour format.







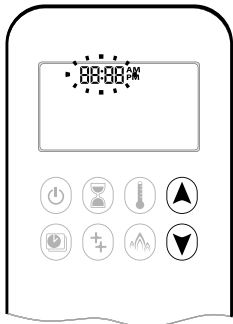

## ■ TIME SETTINGS

Press simultaneously and . Press or to select the number corresponding to the given day of the week (1 - Monday, 2 - Tuesday, 3 - Wednesday, 4 - Thursday, 5 - Friday, 6 - Saturday, 7th Sunday). To confirm, press simultaneously and . The hours will begin to flash. Set the time using or . Press simultaneously and . The minutes will start flashing. Set the minutes with or . To confirm the settings, press and simultaneously or wait.



## ■ CHILD PROOF MODE ACTIVATION

**Activation.** Press  and  simultaneously and. The  icon will appear on the display.

**Deactivation.** With CHILD PROOF on, press simultaneously  and . The  icon will disappear.

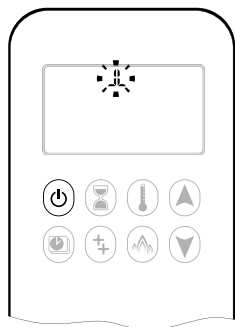
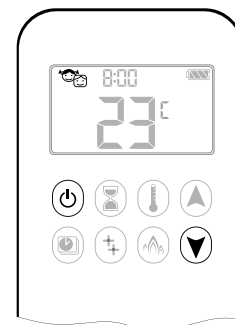

## ■ STARTING THE APPLIANCE (MANUAL MODE)

Press and hold  until you hear two short beeps, then release the button. The heater will start the firing-up procedure. After firing up, the device will automatically set the maximum flame height.

## ■ MINIMUM AND MAXIMUM FLAME HEIGHT / STANDBY (MANUAL MODE)

With the heater working.

### **Minimum flame height.**

Double press . The display will show the symbol “LO” in place of the temperature.

### **Maximum flame height.**

Double press . “HI” will appear in place of the temperature on the display.

### **STANDBY.**



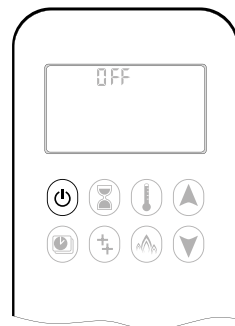
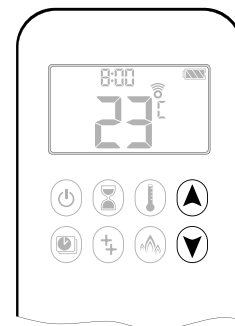





Press and hold . The main burner will be extinguished.





## ■ SHUTTING OF THE APPLIANCE (MANUAL MODE)

With the working heater or heater in a STANDBY mode, press and hold . A flashing message “OFF” will appear in the display in the hours and minutes field. The extinguishing procedure will end when the symbol stops flashing. If the appliance is warmed up, wait 5 minutes before trying to fire it again.

## ■ TIMER (MANUAL MODE, THERMOSTAT, PROGRAMMABLE, ECO)

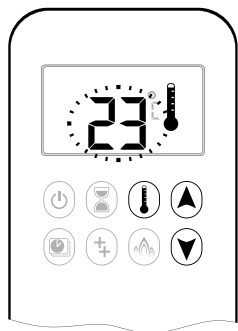
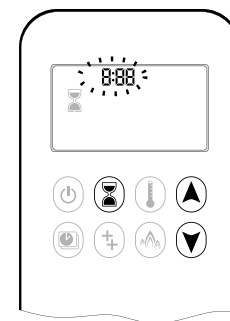

**Turning on.** Press and hold  until  icon appears on the display. The hour field will begin to flash. Use  or  to set the desired value and confirm by holding . The minute field will begin to flash. Set the value with  or  and confirm by holding . The maximum countdown time is 9 hours and 50 minutes. After the countdown is complete, the heater will turn off.

**Turning off.** Press and hold  while the sleep timer is on. The  icon and the countdown will disappear.







## ■ THERMOSTAT MODE

The ambient temperature is constantly compared with the temperature set by the user. The temperature sensor is in the remote control. The flame height is automatically regulated to reach the set temperature.



**Turning on.** Press . The display will show  next to which the desired temperature will appear for a short time, and then the ambient temperature will be displayed.





**Turning off.** With the thermostat mode on, press  / press  or  to switch to manual mode / press  or  to switch to another mode.

**Setting the set temperature.** Press and hold  until the temperature field flashes. Using  or  set the desired temperature and confirm by pressing  or wait.

## ■ PROGRAMMABLE MODE

It allows you to program the switch-on and switch-off time for each day of the week. During operation, the fireplace turns on when the ambient temperature is lower than the set switch-on temperature and switches off when the switch-off temperature is reached. **The switch-on temperature is set in thermostat mode.**

**Turning on.** Press , and the symbols , 1 or 2 and “ON” or “OFF” will appear in the display.

**Turning off.** Press  / press  or  to go to manual mode / press  to go to thermostat mode.

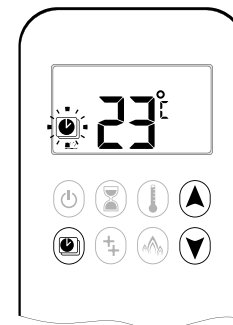

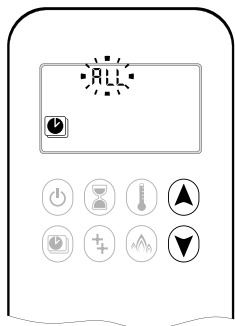

**Temperature settings.** Press and hold the display will flash the symbol, "ON" will appear and the temperature at which the heater will turn on (**set in thermostat mode**). To go to the switch-off temperature setting, press or wait. The display shows "OFF" and the temperature flashes. Using or set the switch-off temperature and confirm with . The set temperatures are the same for every day of the week.

**Day settings.** When the shutdown temperature is set, "ALL" appears in the display. Using or set for which days of the week the mode is to be active (ALL - all week, SA: SU - Saturday and Sunday, 1 - Monday, 2 - Tuesday, 3 - Wednesday, 4 - Thursday, 5 - Friday, 6 - Saturday, 7 - Sunday) and confirm with . For the selected option, you can set two different times for switching the heater on and off.

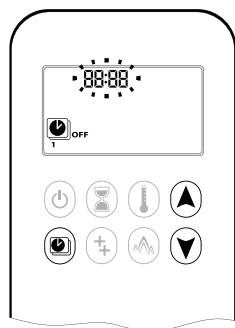
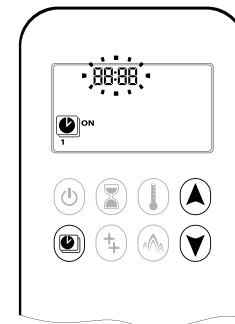

**Setting the switch-on and switch-off time for program 1.** After setting the days, the display will show , 1, "ON" and the flashing field for hours. Using or set the switch-on time and confirm with . The minutes field will start flashing. Similarly to the hour, set the minutes and confirm with . , 2, "ON" appears in the display. The user has the option to enter the settings for **program 2**. If you do not want to enter **program 2**, wait until the procedure ends automatically. If you want to set **program 2**, proceed in the same way as when programming **program 1**. To reset both programs, remove and reinstall the batteries in the remote control.

## ■ ADDITIONAL BURNER

In the case of CALMA series heaters, the function remains inactive.

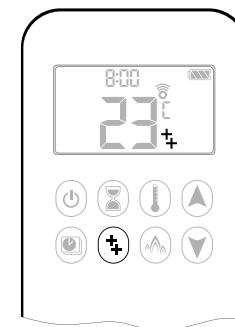

## ■ ECO MODE

The flame height is regulated between its extreme values. If the temperature in the room is lower than the temperature set on the thermostat, the flame height reaches its maximum value and remains at a high level for a longer period of time. If the temperature in the room is lower than the set temperature, the flame height is reduced to a minimum for a long period of time. One cycle takes approximately 20 minutes.

**Turning on.** Press . The icon will appear on the display.

**Turning off.** With the ECO mode on, press . The icon will disappear.

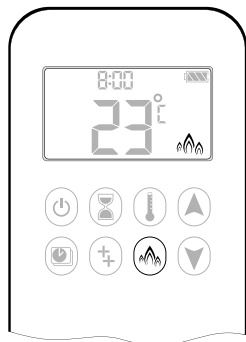



## ■ MYFIRE APP

If the gas heater is controlled via the myFire App and if the thermostat, programmable mode or ECO mode is activated in the app, the “APP” symbol will appear on the remote control display.

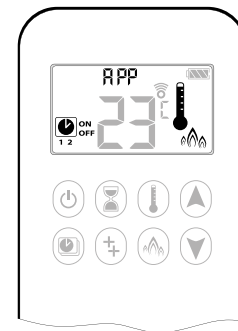

## ■ CONTROL USING THE FB 868D REMOTE (TESC)

In order to be able to control the heater equipped with the TESC automation, make sure that the switch on the control module is **in the ON (I) position**. The remote control is within range of the control module when the symbol  is shown on the display.



Fig. 11. Remote control type FB 868D (TESC) 1 - Day of the week, 2 - Heater status, 3 - Battery indicator, 4 - Light sensor, 5 - Mode selection, 6 - Decreases the flame button, 7 - Current mode, 8 - Hours and minutes, 9 - Connection with the heater indicator, 10 - Ambient temperature, 11 - Remote control lock indicator, 12 - Entering settings, 13 - Increase the flame button, 14 - Turn on / off

**The FB 868D remote control has an automatic protection. To unlock the device, place the remote control in your hand in such a way as to activate the sensors on both sides of it at the same time. The unlocking of the remote control is signaled by the green diode above the SET button. To be able to control the heater, the remote control must be unlocked.**

## ■ SETTINGS OF TIME, TEMPERATURE UNIT ON THE REMOTE

Press and hold **SET** until you hear a beep. Release the button. The display will show a flashing thermometer symbol. Press **MODE**, several times until “**SETUP**” flashes in the display in the top right corner. Press **SET** to be able to make new settings. In the menu, you can set the clock format, day of the week, current time, temperature unit, display backlight.

Using ⊕ or ⊖ make settings for each parameter. To confirm the changes made and go to the next parameter, press **SET**. To go back to the previous parameter, press **MODE**.

**Clock format.** Follow the instructions above. The “**H**” symbol on the remote control indicates that you need to set the clock format. Using ⊕ or ⊖ enter the time format (12 or 24 hours) and confirm by pressing SET. The device will go to the settings of the days of the week.

**Day of the week settings.** Using ⊕ or ⊖ enter the current day of the week (Mo - Monday, Tu - Tuesday, We - Wednesday, Th - Thursday, Fr - Friday, Sa - Saturday, Su - Sunday). Confirm by pressing **SET**. The device will go into time settings.

**Time settings.** Using ⊕ or ⊖ set the hour and confirm with **SET**. The device will go to the minute settings. Repeat the procedure setting the minutes. The device will go to the setting of the temperature unit.

**Temperature unit settings.** Using ⊕ or ⊖ set the temperature unit (Celsius or Fahrenheit) and confirm by pressing **SET**. The device will go to the display backlight settings.

**Backlight settings.** Using ⊕ or ⊖ set the display backlight mode (L-0 - no backlight, L-1 - continuous backlight, L-A - automatic backlight). **No further configuration is required. Press and hold SET to complete the configuration. After this operation, the display will show the default screen with the entered settings.**

## ■ STARTING THE APPLIANCE (MANUAL MODE)

Press and hold  until you hear a short beep. Release the button. The heater will start the firing-up procedure and the display will show “**PILOT**”. After firing up, the display will show the “**ON**”, symbol and the device will automatically set the maximum flame height.

If the heater does not start, the procedure will be repeated automatically two more times. If the heater is still not working, the message “**E00**” will appear on the display. Disconnect the gas supply to the appliance and contact the service.

## ■ MINIMUM AND MAXIMUM FLAME HEIGHT / STANDBY (MANUAL MODE)

With the working heater only.

**Increase the flame height.** Press ⊕.

**Reducing the height of the flame.** Press ⊖.

The heater is controlled by TESC automatics and has seven levels of regulation of the flame height of the main burner.

## ■ SHUTTING OFF THE APPLIANCE (MANUAL MODE)

With the heater operating, press 🔌. When the extinguishing procedure is completed, the message **“OFF”** will appear on the display. If the device is warmed up, wait 5 minutes before trying to fire again.

## ■ TIMER (MANUAL MODE, THERMOSTAT)

This mode allows you to turn off the burning heater after a certain time. The function is available in both manual and thermostat mode.

**Turning on.** Press **MODE** several times until the display shows flashing symbols **“MAN”** and **“Zzz”**, or the thermometer symbol and **“Zzz”**, then confirm by pressing **SET**.

**Turning off.** Press **MODE** several times until **“MAN”** flashes in the display, then confirm by pressing **SET**. The device will start operating in manual mode.

**Countdown time settings.** Press and hold **SET** until you hear a beep. Release the button. A flashing thermometer symbol appears on the display. Press the **MODE** button. A flashing symbol **“Zzz”** will appear in the upper part of the display. Press **SET** to enter the countdown time setting. The default countdown time is set to 1 hour. At this point, it is possible to change the time after which the burning heater turns off using ⊕ and ⊖. The maximum countdown time is 4 hours. After setting the time, confirm by pressing **SET**, or wait a few seconds for the device to do it automatically.

In the timer mode in combination with the manual mode, pressing the **SET** button displays the time remaining to the end of the countdown. If the heater operates in the timer mode in conjunction with the thermostat mode, pressing **SET** several times allows you to alternate displaying both the time remaining until turning off and the set temperature.

## ■ THERMOSTAT MODE

The ambient temperature is constantly compared with the temperature set by the user. The temperature sensor is in the remote control. The flame height is automatically regulated to reach the set temperature. When the thermostat mode is on, the heater adjusts the flame height depending on the set temperature. If the set temperature is reached, the flame of the main burner will be reduced every minute until it is completely extinguished (only the control burner is burning). The control burner will turn off after 30 minutes if the ambient temperature does not drop below the temperature set in the thermostat mode.

**Turning on.** Press **MODE** several times until the display shows a blinking thermometer symbol and then confirm by pressing **SET**.

**Turning off.** Press **MODE** several times until **"MAN"** flashes in the display, then confirm by pressing **SET**. The device will start operating in manual mode.

**Temperature settings.** Press and hold **SET** until you hear a beep. Release the button. A flashing thermometer symbol appears on the display. Press **SET** to set temperature values. The setpoints of individual temperatures can be adjusted using ⊕ and ⊖. New settings should be confirmed with **SET**.

In the thermostat mode, the set temperature can be set for three variants:

- Day variant - the sun symbol appears on the display. The default temperature for this variant is 24 °C.
- Night variant - the display shows the crescent symbol. The default temperature for this variant is 18 °C.
- Minimum temperature variant - the display shows the snowball symbol. The default temperature for this variant is 5 °C.

In the thermostat mode, the display shows the symbol corresponding to the given temperature variant, and pressing the SET button displays the set temperature. **In the case of the CALMA series, only the day variant remains active.**

## ■ ENVIRONMENT PROTECTION AND RECYCLING

Hitze gas heaters are equipped with automatics with an electric system, therefore they are subject to the Directive of the European Parliament and of the Council 2012/19 / EU of July 4, 2012. This is confirmed by placing the marking from Annex IX of the above-mentioned directive on the device label. The package in which the heater was delivered should be disposed of in an appropriate manner. After the period of operation, the user should hand over the used heater along with the accessories to the appropriate institution dealing with the disposal of this type of appliances. Electronic equipment in the form of a controller, control module, remote control and all other electronic components should be dismantled from the device and subject to selective collection of used electrical and electronic equipment. From the heater, the glazing made of heat-resistant ceramics should be removed. The steel body of the device should be disassembled and cleaned of silicone gaskets. If the devices are equipped with an accumulation lining, they must also be dismantled. All received materials should be segregated and recycled.

The used batteries in the receiver and the remote control should be placed in special containers for this type of waste. The containers are located in places determined by the appropriate municipal or commune services.

## ■ ERROR CODES AND RESET ERRORS

All CALMA series gas heaters are equipped with a remote control. In the event of a malfunction of the appliance, a message with an error number will be displayed on the remote control display. To reset the error, regardless of the type of automation, press and hold the button responsible for starting the heater for a while. **If an error appears on the display, read its description, take the suggested actions and try to restart the heater. If the error occurs again, shut off the gas supply and contact the service center. In the event of an error other than the one shown in the tables below, shut off the gas supply and contact the service center.**

## MAXITROL GAS CONTROL VALVE

ERROR CODE	DESCRIPTION	CAUSE
F04	Unsuccessful firing-up attempt.	No gas. There is air in the gas system. No spark. Thermocouple does not detect flame. Make sure that the heater has a gas supply and a spark appears on the control burner during the ignition procedure. If the above does not occur, cut off the gas supply and contact the service center.
F06	Three unsuccessful firing-up attempts, carried out within 5 minutes.	Same as above. Error permissible only when venting the gas installation is being carried out.
F07	Flashing battery indicator on the remote control display.	Weak batteries in the remote control. Replace the batteries in the remote control.
F09	Heater is not controlled.	Remote control and control module are not paired correctly. Perform pairing procedure again.
F46	The device is not responding.	No or poor communication between the remote control and the control module. Weak or discharged batteries in the control module. Replace the batteries in the control module.

## TESCO1 GAS CONTROL VALVE

ERROR CODE	DESCRIPTION	CAUSE
E00	Unsuccessful ignition attempt after the end of 3 cycles.	No gas. There is air in the gas system. No spark. Thermocouple does not detect flame. Make sure that the heater has a gas supply and a spark appears on the control burner during the ignition procedure. If the above does not occur, cut off the gas supply and contact the service center.
E01	Heater turns off.	Weak or inadequate flame on the control burner. Clean the filter in front of the gas inlet to the control burner. Check that the decorative elements do not interfere with the control burner operation.
E02	Heater turns off.	The temperature of the control module has reached 72 ° C. Poorly made heater housing.
E06, E07	The heater does not start up.	The batteries in the control module are completely discharged. <b>In this case, random error codes may be displayed.</b> Replace the batteries in the control module.

## SERVICE AND MAINTENANCE

### CAUTION

***Service activities that require removal of the front glazing should be performed on a cooled down fire-place with the gas supply cut off. Service of the device may only be performed by a qualified service technician with appropriate entitlements. After the performed activities, the service technician fills in the inspection report. The scope of performed works should be recorded in the Remarks field.***

The appliance and the flue system should be periodically inspected and at least once a year. The chimney system should be periodically inspected at least twice a year. In order to have access to the automation components installed outside the heater body, the inlet grate (bottom one) installed in the housing of the device must be disassembled. All consumables and service agents are available from the manufacturer. During the inspection, the service technician is obliged to:

- Replace the batteries in the remote control and the control module.
- Inspect the glasses for damage. Glass with deep scratches and / or cracks must be immediately replaced with new one.
- Checking the condition of the glass sealing. Damaged gaskets should be replaced with new ones.
- Checking the condition of the ceramic elements of the burner. Cracked ceramic logs should be replaced with new ones.
- Dismantle the ceramic burner parts and other decorative materials in order to clean the combustion chamber. The combustion chamber should be wiped with a damp cloth. Do not clean the fireplace with caustic agents. After the activities performed, the dismantled elements should be reinstalled.
- Clean the control burner module from any soot deposits.
- Check the air-flue gas system. If the chimney system requires unblocking / cleaning, carry out the required activities.
- Checking the tightness of the gas installation of the heater and the gas connection.
- Check the electrical installation of the automatic gas control system. Damaged electric cables and /or cables showing signs of corrosion must be replaced immediately.
- Clean windows. Do not use abrasive materials or chemicals not intended for this type of materials to clean the windows. Most dirt can be removed with a dry cloth. More stubborn stains should be removed with agents designed for cleaning heat-resistant ceramics.

## ■ FRONT GLASS DISASSEMBLY

Regardless of the heater's glazing version, only the front glass needs to be disassembled when servicing the device. CALMA series gas heaters are equipped with an innovative glazing assembly system. In the new solution, the windshield is equipped with steel slats. The lower strip has a flange on the side of the chamber, creating support for the entire structure. The upper strip is pressed against the body of the heater through a specially designed mechanism located above the glass.

### C A U T I O N

***When lowering the pressure profile, use the dedicated handle and control its movement all the time. If the glazing is pressed too suddenly, it may be damaged. To reinstall the glazing after servicing, place it in the initial position in the heater and, using the handle located in the pressing profile, slowly lower it to its lower extreme position. Pay special attention to whether the tightness of the heater chamber has been maintained after the installation of the glass.***

To disassemble the glass, follow the instructions below:

- Unlock the safety element. Using a flat-head screwdriver, lift the stopper of the hold-down mechanism.
- Raise the glass pressing profile. The mechanism has been designed in such a way that when the clamping profile is set in its upper extreme position, the profile does not drop.
- Using the flanges on the top slat, lift the glazing so that the bottom slat is above the bottom windowsill of the heater.
- Tilt the glass as shown in fig. 14 and carefully take it off.

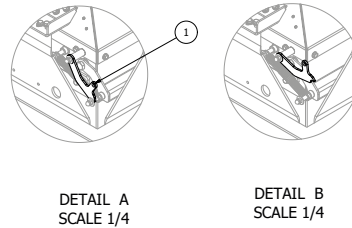

Fig. 12. Unlocking the door pressure mechanism lock: 1 - locking mechanism lock (locked mechanism)

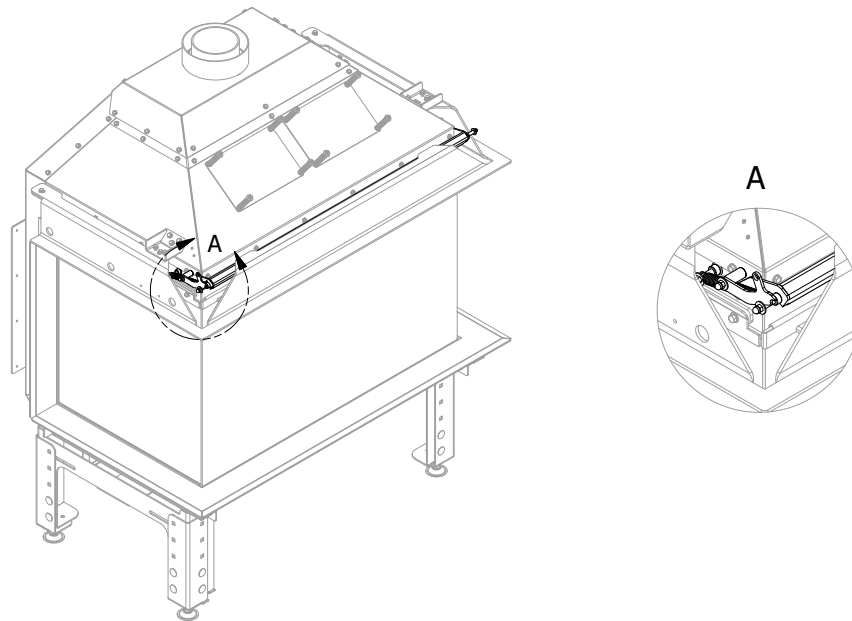

Fig. 13. Raising the profile pressing the glazing

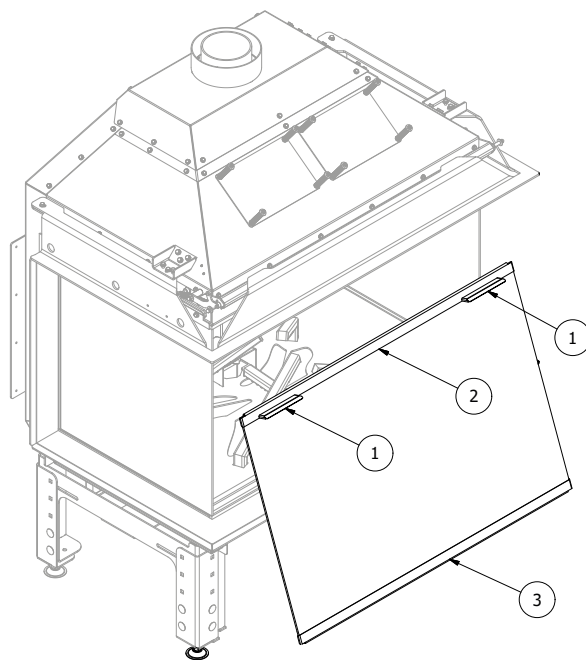

Fig. 14. Removing the front glazing: 1 - handle; 2 - upper strip; 3 - bottom strip

## ■ REMOVAL OF THE MAIN BURNER AND ANTI-EXPLOSION FLAPS

CALMA series gas heaters have a multi-module burner, where its first part (lower), mounted below the combustion chamber, is a manifold with multi-point gas distribution, in which injectors responsible for delivering the right amount of fuel to the main burner are installed. The second part of the burner (top) is at the same time the base of the combustion chamber of the device and rests on supports screwed to the heater body. To the base there are profiles with outlet nozzles on which dedicated ceramic elements imitating wooden logs are applied. In the CALMA 120 heater, the upper part of the main burner consists of two modules.

CALMA series devices are equipped with lower and upper anti-explosion flaps, which makes them completely safe, even in the event of unforeseen random events. Explosion-proof dampers are sealed with a silicone high-temperature gasket, and their design is based on pressure springs placed on guide screws. **Explosion-proof dampers may only be disassembled when checking the tightness of gas connections. It is forbidden to use the gas heater without tightly installed flaps.**



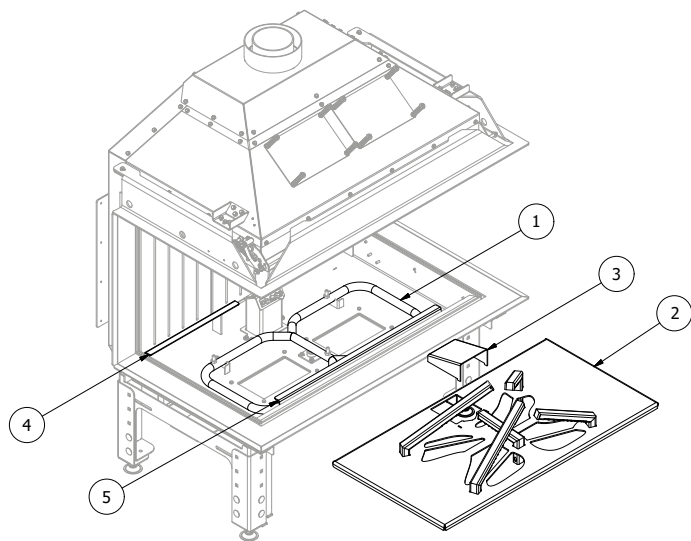

Fig. 15. Main burner disassembly: 1 - lower part; 2 - upper part; 3 - control burner cover; 4 - rear bracket; 5 - front bracket

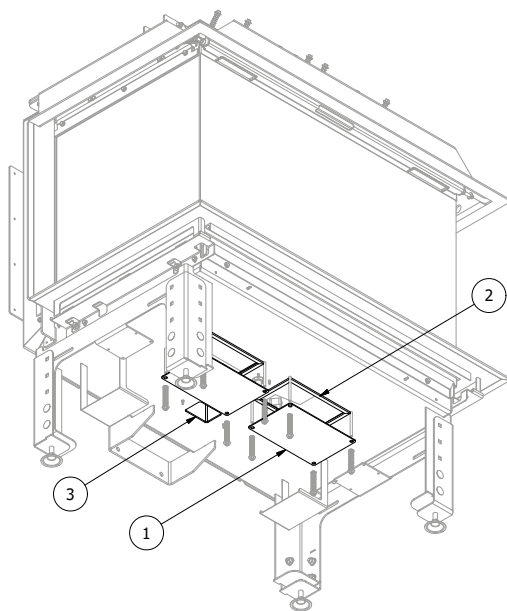

Fig. 16. Dismantling of anti-explosion dampers (of revisions): 1 - damper plate; 2 - sealing; 3 - control burner channel

## ■ INSPECTION OF HEATER GAS INSTALLATION TIGHTNESS

The tightness check should be carried out during the first start-up of the heater at its destination. All gas connections included in the internal installation of the device and the connection to the gas installation of the building should be subject to inspection. The check should be performed using a handheld gas detector with a valid inspection and / or calibration certificate.

**The inspection may only be carried out by a person with the necessary qualifications confirmed with appropriate permissions.**

## ■ TERMS OF WARRANTY

### C A U T I O N

***The condition for obtaining the warranty is to have a completed Warranty Card, proof of purchase, protocol from the installation of the device and a protocol from periodic inspections of the heater. The device automatically loses its warranty if it has been installed or operated in a manner inconsistent with the guidelines contained in***

In order to submit a complaint, the Buyer should send the notification to the address [reklamacje@hitze.pl](mailto:reklamacje@hitze.pl). All information on the warranty conditions and the method of submitting complaints are available in the Warranty Card delivered with the device.

## ■ GAS HEATER INSTALLATION PROTOCOL

GAS HEATER INSTALLATION PROTOCOL			
Model name		The type of gas in the installation	
Heaters Code		Gas pressure in the installation	
Serial number		Date of installation	
Approvals number / entitlements number		Legible signature	
Address of installation			



[mycalma.eu](http://mycalma.eu)