



Installation and User Manual

Model

TP-16 / TP-24/ TP-28 / TP-30

TP-25 / TP-35

Pellet Central Heating Stove - Boiler



Tested according to DIN EN 14785

EN

TABLE OF CONTENTS

1. INTRODUCTION	3
2. FEATURES.....	3
3. WARNING.....	4
4. INSTALLATION AND CONNECTION	4
4.1 GENERAL	4
4.2 SAFETY	5
4.3 SANITARY	5
4.3.1 ELECTRICITY	6
4.3.2 FLUE PIPE CONNECTION.....	6
4.3.3 MINIMUM SAFETY DISTANCES	10
5. CONTROL PANEL	11
5.1. ERROR CODE AND EXPLANATION.....	12
5.2. MENU FUNCTIONS	13
5.2.1 COMBUSTION FUNCTIONS MENU	14
5.2.1.1. LEVEL.....	14
5.2.1.2. AUGER CALIBRATION	14
5.2.1.3. FAN CALIBRATION	14
5.2.2. HEATING MANAGEMENT	14
5.2.2.1. BOILER THERMOSTAT.....	14
5.2.2.2. HEATING POWER.....	14
5.2.2.3 SUMMER- WINTER MENU	14
5.2.4. CHRONO MENU	15
5.2.5. LOADING MENU	16
5.2.6. TP30 WOOD MODE	16
5.2.7. TIME AND DATE MENU	16
5.2.7. LANGUAGE MENU.....	16
5.2.8. ENTRANCE MENU.....	16
5.2.9. SYSTEM (PARAMETERS) MENU	17
6. CLEANING AND MAINTENANCE.....	17
6.1 FLAME PIPES CLEANING	20
6.2. COMBUSTION POT CLEANING	23
6.3 ASH TRAY 1 AND ASH TRAY 2 CLEANING	23
7. GENERAL WARRANTY AND POLICIES.....	23

1. INTRODUCTION

Pellet stoves and boilers are easy-to-use domestic heating appliances. They are fully automatic and can be used inside and outside the house. These indoor heating units combines pleasure with a fireplace view. These are independent heating units that provides heat dissipation of radiators.

You have a stove with European Standards Quality Certificate.

Please read the user manual, carefully. It includes information on product functions and easy-to-use information. Use of these informations increases the product quality and extend its life. You can properly protect the fuel and the environment.

Warranty of the product depends on the right use of installation and instructions as described in the guide.

We recommend you to keep this guide in order to reach the information about the correct use of the stove at the beginning of every winter.

2. FEATURES

TECHNICAL FEATURES	TP-16	TP-24	TP-28	TP-30	TP-25	TP-35
Inside use	√	√	√	√	--	--
Outside use		--	--	--	√	√
Power (kW)	16	24	28	30	30	28
Boiler in-out diameter	1"- 3/4"	1"- 3/4"	1"- 3/4"	1"- 3/4"	1"- 3/4"	1"- 3/4"
Sanitary water in-out	-	-	-	-	-	-
Operation pressure	1-1,5 bar	1-1,5 bar	1-1,5 bar	1-1,5 bar	1-1,5 bar	1-1,5 bar
Flue pipe diameter	80 mm	80 mm	80 mm	100 mm	80 mm	80 mm
Pellet storage capacity	20 KG	25 KG	25 KG	25 KG	50 KG	100 KG
Efficiency	94%	93%	93%	92%	92%	85,24%
Electric	230 V-50Hz	230 V-50Hz	230 V-50Hz	230 V-50Hz	230 V-50Hz	230 V-50Hz
Weight	188 kg	191 kg	210 kg	295 kg	200 kg	224 kg
Boiler capacity	45 lt	45 lt	45 lt	55 lt	45lt	45 lt
Radiator capacity	5-7 meter	7-11 meter	7-11 meter	7-11 meter	7-11 meter	7-13 Metre

3. WARNING

- USE ONLY 6MM NATURAL PELLETS MANUFACTURED ACCORDING TO DIN PLUS STANDARTS.
- **DO NOT USE** 8MM OR 10 MM PELET, OLIVE SEEDS, CHERRY SEEDS, HAZELNUT SHELL ETC.
- CLEAN THE FIRE POT EVERYDAY.
- THE FLAME TRANSMISSION PIPES MUST BE CLEANED WITH THE CLEANING MECHANISM.(PLEASE LOOK AT MAINTENANCE AND CLEANING PART)
- AT THE END OF THE WINTER, GENERAL MAINTENANCE AND CLEANING MUST BE CARIED OUT AND THE FUEL STORAGE MUST BE EMPTIED.
- DAMAGES CAUSED BY USING INAPPROPRIATE PELLET AND NON-REGULAR CLEANING ARE NOT COVERED BY WARRANTY.
- SMOKE AND SMELL IS NORMAL AT FIRST USING. JUST VENTILATE THE ROOM.
- DO NOT TOUCH PAINTED PARTS DURING OPERATION TO AVOID DAMAGING ON PAINT.
- THE FROST PROTECTION OF THE PUMPS WORKS WHEN THE HEATING WATER DROPS BELOW + 5° C, AND TO PREVENT BLOCKING FROM CORROSION AND SEDIMENT, THE SYSTEM AUTOMATICALLY OPERATES THE PUMP FOR 3-10 SECONDS EVERY 24 HOURS. THEREFORE, DO NOT UNPLUG THE PRODUCTS DURING THE WHOLE YEAR.
- **BOILER WATER DEGREE SHOULD NOT BE LOWER THAN 60°.**
- **THE PROBLEMS CAN BE OCCURED IN CASE WRONG/LOW QUALITY PELLET USING AND CLEANING IS NOT MADE, ARE NOT COVERED BY THE WARRANTY.**

4. INSTALLATION AND CONNECTION

4.1 GENERAL

All the inspections for the pellet stove are done according to the stipulated standards. It complies with the prescribed parameters related to combustion efficiency and flue gas emissions. The product mentioned in this manual has been tested by the approved bodies according to EN 14785 and EN 303-5 Standard.

The packaging of the stove protects the product from damage in the best possible way. However, the stove or its accessories may still be damaged during transport. Therefore, after removing the stove from the package, check whether it is complete and undamaged. In case of any damage, notify your dealer. If dealer or manufacturer are not informed about the damage and not presented the proof, the damages are not covered by the warranty.

4.2 SAFETY

- * Product must be installed by an authorized person.
- * Before installing the product, it should be determined whether the bearing capacity of the floor to be installed is durable to the product. In case of insufficient bearing capacity, appropriate measures should be taken. If the floor where the stove is to be installed is flammable or heat-sensitive, you should place a base (eg marble or glass base).
- * Care must be taken to ensure that the ventilation conditions of the place where the product is installed and frost protection measures are taken (such as antifreeze). The problems can be occurred in case antifreeze is not used, are not covered by the warranty.
- * The pellet stove can operate in conjunction with the existing multiple chimneys. In addition, the stove should not be connected at places such as the aspirator chimney and ventilator.
- * Chimney must be cleaned at least twice a year.
- * Product needs to be connected to the chimney with a shortest distance.
- * Always check the water level in the stoves and radiators with the manometer before the first installation (1 - 1.5 bar range). If there is, take the air from the radiators.
- * The central heating boilers and stoves cannot be used without water. Our company is not responsible for damages caused by running without water.
- * In order to get better heat efficiency and extend the life of the product, qualitative pellet and wood fuel should be preferred. Do not use moist or wetted pellet, sawdust, coal etc.
- * Care must be take to ensure maintenance and cleaning of the radiators are made.
- * Since the central heating pellet stoves are designed according to the interior spaces and give heat to the environment, they should not be installed in places such as bathrooms, shelter, cellar. And they should not be used for cooking.

4.3 SANITARY

It is recommended that the radiator installation connection needs to be carried out by an authorized person for regular and comfortable operation. Our company is not responsible for any damage related to the installation.

After the safety precautions and precautions described above, the pellet stove or boiler can be installed up to last a few radiators without using too many elbows with the installaton line pipes 1 "- 3/4" METAL or PVC pipes. In this way, the hot water will circulate more easily and the temperature in the radiators is felt in a short time. 1/2 " METAL or PVC pipes can be used. The installation of the main pipes to the pellet stove should be securely connected to the radiators by using the fittings(Gland, nipple, valve). After the connection is done the system will be filled with water by the authorized

person. After the installation, the leakage in the installation, radiators and valves should be checked and the air in the installation should be emptied. This all needs to be done by the authorized person.

*According to the weather conditions of the region, it is recommended to use 1/3 portion antifreeze against corrosion and freezing.

Pellet stove is a fully automatic product. Parts such as expansion tank, circulating pump, thermostat, safety valve and sensor are securely placed in the product.

It is a comfortable product which provides fuel firing with resistance, helical and reducer group, fuel loading, chimney traction and blowing with fans.

4.3.1 ELECTRICITY

The electricity must be 230V / 50 Hz 10A. Our company is not responsible for any damage that may occur in case of any voltage drop or rise. We recommend taking necessary measures as it does not include the warranty.

4.3.2 FLUE PIPE CONNECTION

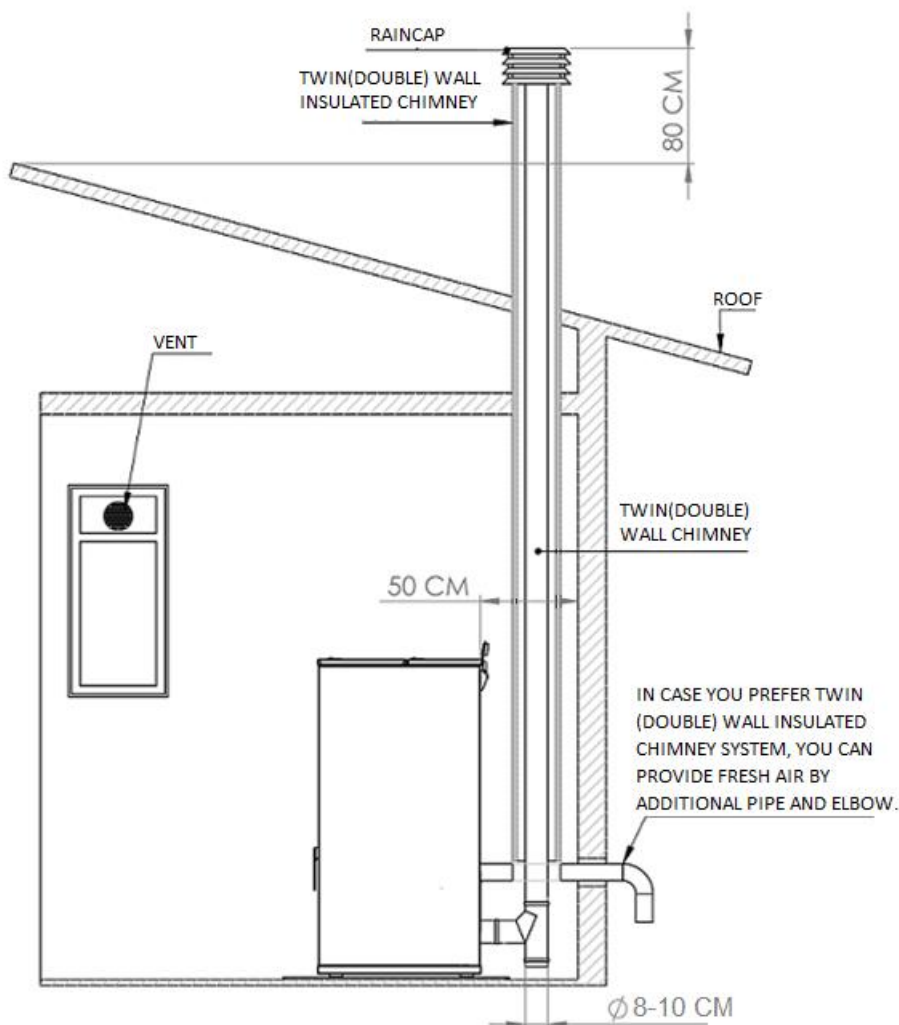

We recommend the use of twin(double) wall or twin(double) wall insulated system for chimney connection.

- In the interior spaces, by using twin wall chimney system, exhaust gas can be throughed out to the outside, at the same time fresh air provided to inside. Twin insulated chimney should be used on the outside.
- In the interior spaces, by using twin wall insulated chimney system, exhaust gas can be throughed out to the outside. In this case, you can provide fresh air by additional pipe and elbow.
- To provide fresh air easily, a vent should be used on the nearest window where stove is installed.
- Chimney or twin wall insulated chimney, should be at least 80 cm higher than the highest point of the roof.
- Use rain cap or wind cowl at the end of the chimney to avoid to come inside anything(bird,etc...). Distance between raincap and chimney end should be 30-40 cm.
- The pellet stove can operate in conjunction with the existing multiple chimneys. In addition, the stove should not be connected at places such as the aspirator chimney and ventilator.
- The chimney can be given directly out of the pellet stove at a short distance, or it can be connected to the existing chimney at short distance.
-

ATTENTION !!!

THE PIPE AND ELBOWS USED UP TO THE CHIMNEY OUTPUT AND INPUT NEEDS TO BE THE SAME DIAMETER. BY THE INPUT OF THE CHIMNEY A REDUCTION MUST BE USED. MAXIMUM 4 METERS PIPES AND 2 ELBOWS NEEDS TO BE USED. PIPE JOINTS SHOULD BE TAPED TO CONNECTOR OR ALUMINUM BAND.

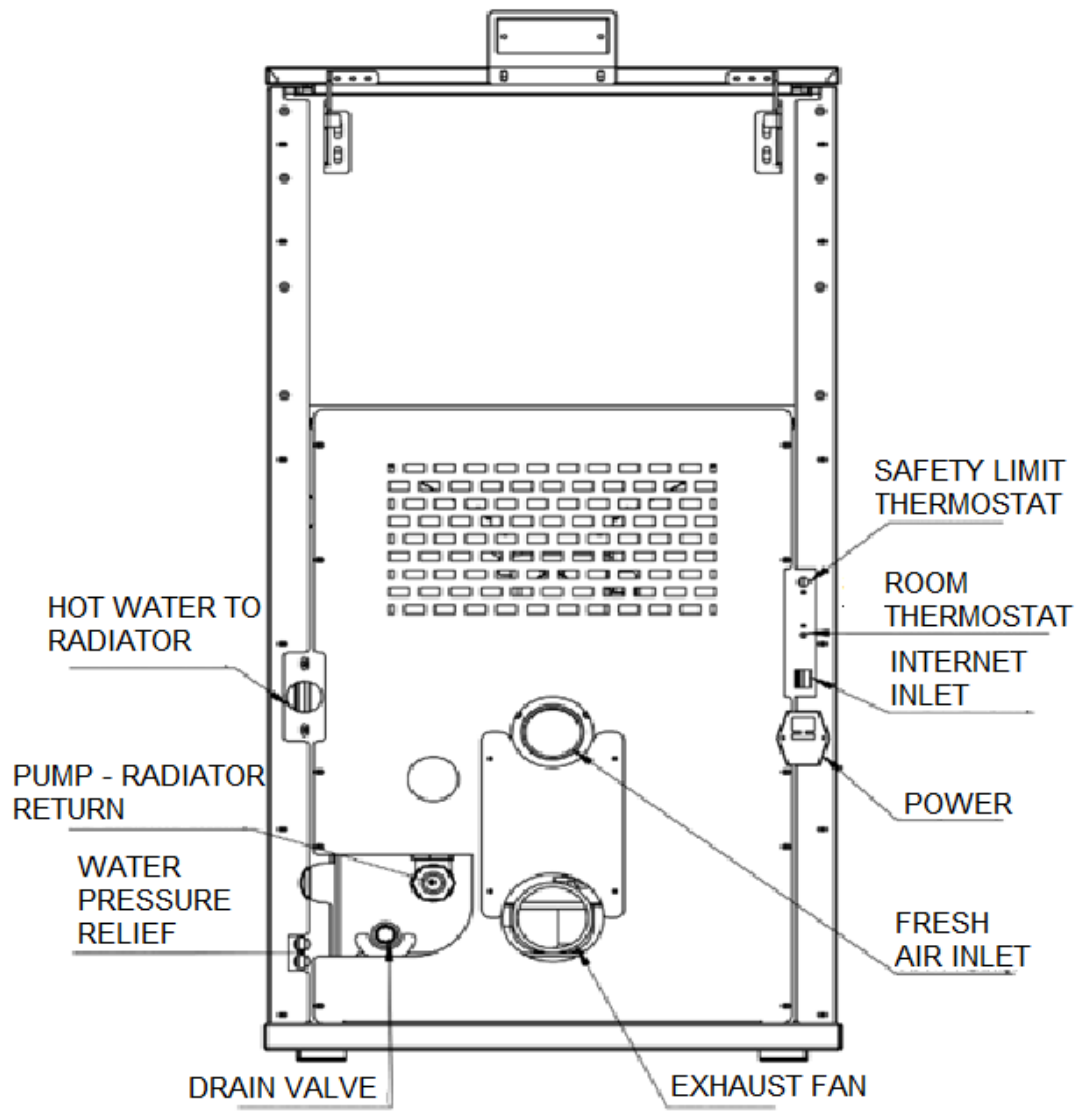

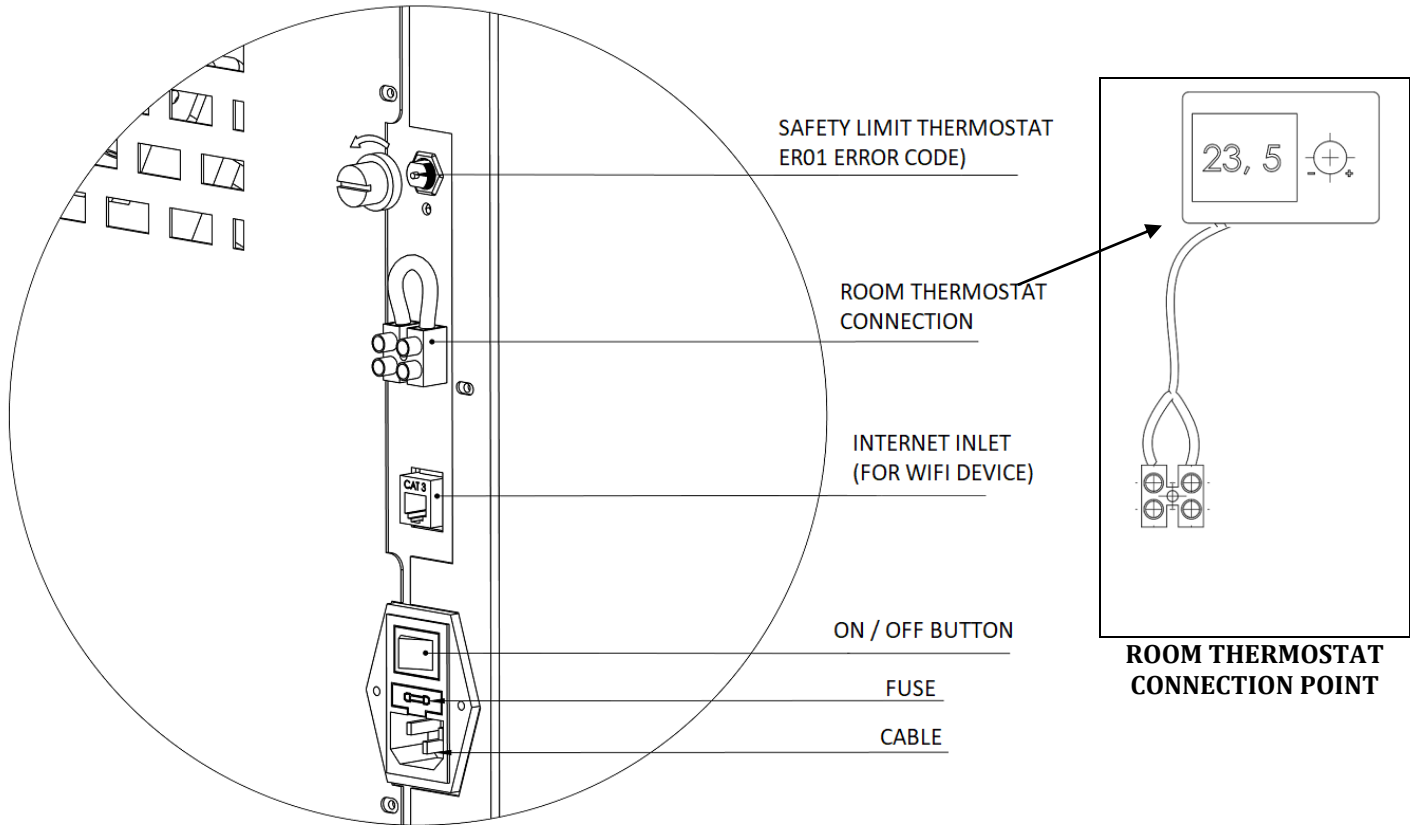

4.3.3 MINIMUM SAFETY DISTANCES

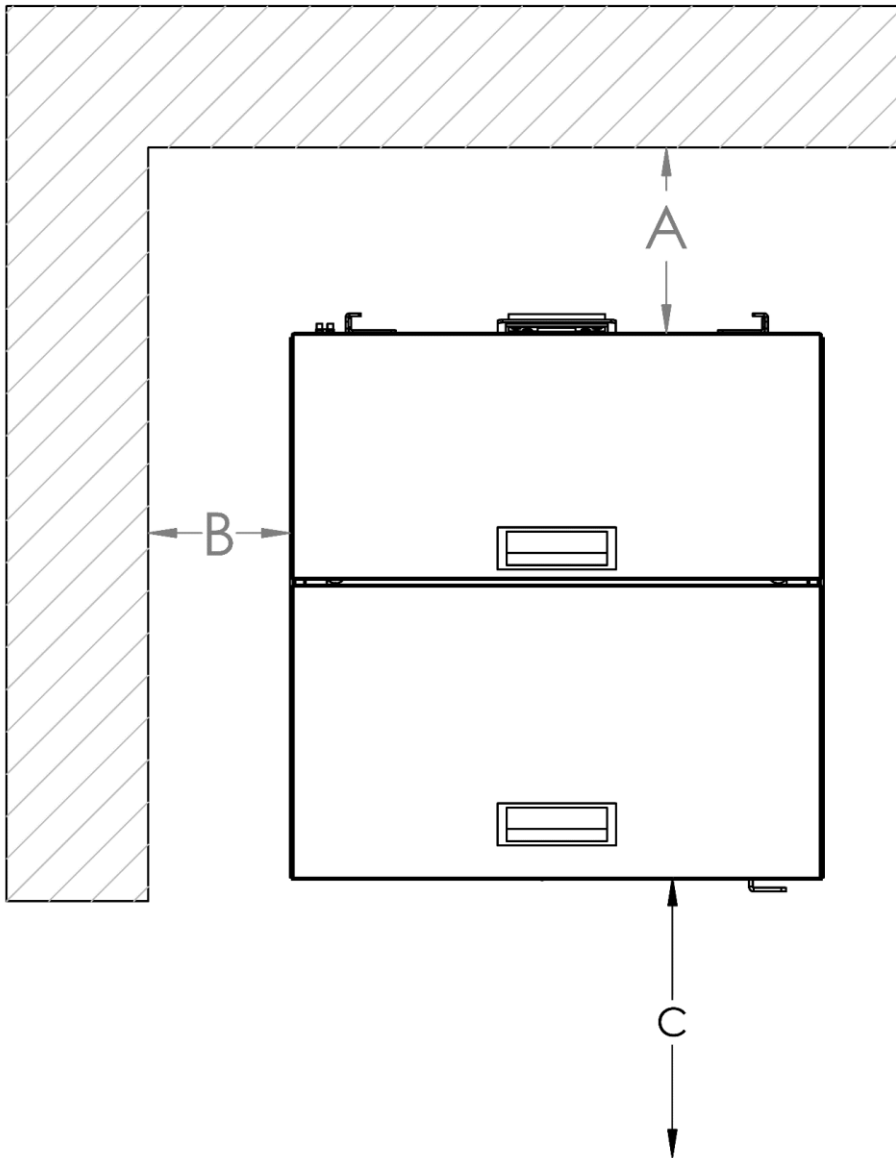

- A 50 cm from rear wall
 - B 40 cm from lateral wall
 - C 100cm from front side
- Flammable materials and furniture should not be placed at a distance of 100 cm in the radiation area (C) of the flame monitoring cover.

While installing the stove, the fire regulations and chimney's instructions must be complied. For any related questions please ask the chimney provider. Minimum distances to be observed in flammable or heat-sensitive materials (eg furniture, wallpaper, wood panels) (see diagram above) are:

This distance can be reduced to 40 cm when the protection panel is placed between the stove and the materials that are likely to burn.

Minimum distances for flammable materials and furniture are indicated on the product label and must not be exceeded. If the floor where the stove is to be installed is flammable or heat-sensitive, you should place the product on the ground protection plate (eg marble or glass base).

5. CONTROL PANEL

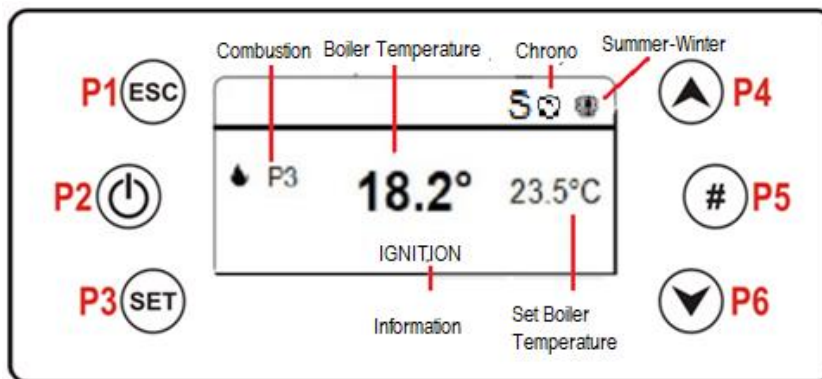

FUNCTIONS	BUTTONS	DESCRIPTION	S
EXIT		Use P1 to exit from menu or submenu and to return previous menu	P1
ON- OFF		Wait for 3 seconds by touching the P2 to switch on and off	P2
RESET		(Er05) Wait for 3-4 seconds by touching the P2 to reset the error code	
MENU ENTRANCE		Use the P3 to access the menus	P3
SUBMENU (ENTRY)		Use the P3 to enter a submenu in the current menu.	
SAVE		Use the P3 to save data or values in the current submenu.	
MENU CHANGE		Use the P4 and P6 s to switch between menus, submenus data and values. When the P6 is touched on the home screen the chimney temperature - room temperature - air speed - the chimney fan, auger speed will be shown.	P4 P6
SUB MENU CHANGE			
TIME SLOT ACTIVATION		After the adjustment of time, the selected time slot will be activated by P5 .	P5

5.1. ERROR CODE AND EXPLANATION

NOTE: When you encounter the error codes, firstly be sure stove and parts don't work. You will see "BLOCK" on the screen. After checking and correcting the following connection, parts and values according to the error code, the error code must be cleared by -pressing the P2 for 3 seconds. When the error code is erased, contact your dealer for any malfunctions that persist.

Error code	Explanation	Solution
Er01	Safety limit thermostat error - overheating of fuel chamber (over 90°)	In the first screen when the stove display starts to work, ER01 may be encountered. Push  button to delete the error code. Check the sanitary valves and pump. Push the black tip of the safety limit thermostat inside, which is on the back side of the boiler.(see pg.9)
Er02	Chimney emission safety switch error	Check chimney connections and chimney emission. Be sure chimney and second ash tray is clean
Er03	Chimney outlet temperature drop or auger failure	Check if there is fuel in the combustion chamber and whether the fuel is supplied by the coil.
Er04	Overheating of Boiler Water Temperature	Check whether sanitary valves are open and pump is working. Take air from radiators.
Er05	Chimney outlet over temperature error / flue temperature sensor error or cleaning error	This error occurs when the calibration values are increased or when the general cleaning time is reached. Please give a general cleaning of the product.
Er07	Chimney emission fan motor error	Check that your chimney is not clogged and reset it. Be sure chimney and second ash tray is clean. If the error still persists, contact your dealer.
Er08	Chimney emission fan motor encoder error	Reset the product, contact your dealer if the error still persists.
Er09	Low Pressure on Boiler Water	Check the manometer and in case water is lack, complete the water.
Er10	High Pressure on Boiler Water	Check the manometer and be sure water pressure is on 1-1,5 bar range. If the pressure is high, decrease the pressure by discharging water from sanitary discharge valve or

		radiators.
Er11	Date and Time Error	Check the date and time
Er12	Ignition failure error	This error can occur due to pot pullution or resistanse, check the resistance and clean the pot.
Er15	Safety Low Voltage	Check voltage fluctuation
Er16	Display - Motherboard connection error	Check the display and the cable between display and control board.
Er44	Open Door	Close the door and check door sensor.

SAMPLE VISUALS; when touching the  P4 buttons for 1 time, the upcoming operation values. (Visual is an example, ignore the numbers.)

Chimney Output S. [° C]	22
Pressure [mbar]	0
Fan Speed [rpm]	0
Auger [s]	0,0
Type [nr]	1
Product Code 510	1111

5.2. MENU FUNCTIONS

Touch the  P3 button to enter the user menu. The following menus will appear on the screen.

Combustion Management

Heating Management

Remote control

Chrono



Loading

Press  P3 for 3 seconds to enter the input menu, the following menu will appear on the screen.

Input settings

Home menu

System menu

Use the  P4 and  P6 buttons to switch between menus. Use the  P3 button to access the desired menu.

5.2.1 COMBUSTION FUNCTIONS MENU

 Touch the P3 button to enter the submenu. You can enter the Combustion Management menu again with the P3 button. In the Combustion Management menu, there are Level, Auger Calibration and Fan Calibration menus.

5.2.1.1. LEVEL

In this menu, the pellet combustion speed can be changed with the help of P4 and P6 buttons. Ex: 1 - 2 - 3 - 4 - 5 - 6 - A (A = Auto) Use P3 to save.

5.2.1.2. AUGER CALIBRATION

Enter the pellet loading speed settings with  P3. Use P4 and P6 to slow the pellet loading speed or adjust the acceleration values in the display (+7...0...-7). Use P3 to save. Use P1 ESC to exit the menu.



5.2.1.3. FAN CALIBRATION

Enter with the P3 button for fan speed control. Use P4 and P6 to slow down the chimney fan speed or set acceleration values in the display (+7...0...-7). Use P3 to save. Use P1 ESC to exit the menu.



5.2.2. HEATING MANAGEMENT

Press the P3 button to enter the submenu. You can enter the Heating Management menu again with the P3 button. Boiler thermostat, heating power and summer-winter menus are available in the Heating Management menu.





5.2.2.1. BOILER THERMOSTAT

Press the  P3 button to enter the submenu. To change the boiler thermostat level press  P4 and  P6. It can be set in max.75- min 50. Use P3 to save.

5.2.2.2. HEATING POWER

Press the  P3 button to enter the submenu. Use  P4 and  P6 to change the blowing fan values. Ex: 1 - 2 - 3 - 4 - 5 - 6 - A (A = Automatic Blowing) Use the P3 button to record



5.2.2.3 SUMMER- WINTER MENU

Press the  P3 button to enter the submenu. With  P4 and  P6 button, winter mode can be selected and with  P3 button you can save it. Use P1 ESC to exit. (Summer mode only applies if there is a hot water boiler system.)



5.2.3 REMOTE CONTROL MENU

Remote control is not available

5.2.4. CHRONO MENU

Press the  P3 button to enter the menu. The display shows the chrono management menu. Enter the modality menu by touching the  P3 button. The screen on the right-up will appear. In the chrono menu, the daily / weekly / weekend time settings are usually switched on / off. When turned on, the display will show the time in the left corner and nothing will be visible in the closed position. When the P2 button is pressed in the modality menu, the timer can be set to ON or OFF. To select daily, weekly or weekend programming and to set the clock, the timer menu must be entered with the P3 button. When programming needs to be done, the steps in the table below should be followed. 3 time slot opening and 3 time slot shutdowns can be programmed for each day. To set each time slot, use the  P3 menu button to flash the time slot on the display and the P4 and P6 buttons to increase or decrease the time.

OFF
Daily
Weekly
Weekend

After choosing the time slot selection, activate it with  P5 button (when it becomes actived, there will be a “v” sign on the right side. Use  P3 menu button to save and use P1 ESC to exit each step.

Example: DAILY PROGRAMMING

Daily	Monday	Monday	
Weekly	Tuesday	OPEN	CLOSE
Weekend	Wednesday	09.30	11.15 ✓
	Thursday	00.00	00.00
	Friday	00.00	00.00



Example: WEEKLY PROGRAMMING

Daily	Monday- Sunday	
Weekly	OPEN	CLOSE
Weekend	09.30	11.15 ✓
	00.00	00.00
	00.00	00.00

Example: WEEKEND PROGRAMMING (MONDAY-FRIDAY OR SATURDAY- SUNDAY

Daily	Monday- Friday	Monday - Friday	
Weekly	Saturday- Sunday	OPEN	CLOSE
weekend		10.00	12.15 ✓
		14.00	16.00 ✓
		00.00	00.00















5.2.5. LOADING MENU

Press the  P3 button to enter the submenu. It will manually load the pellet when it is turned ON with the  P4 button. Pellet loading will stop by selecting OFF mode. Use P1 ESC to exit. (This is only a process to fill the pot and accelerate the ignition during the first burning phase when the product is in the OFF mode.)



5.2.6. TP30 WOOD MODE

6th Level in combustion menü is wood mode for TP-30 model. You can set this Level by P4 and P6 button.

5.2.7. TIME AND DATE MENU

Press the  P3 button to enter the submenu. The time setting menu appears first. Press the  P3 button again to set the current time. The numbers will flash and use  P4 and  P6 to change the digits. After setting, press the  P3 button. Use the  P4 button to move to the minute setting side. Login with the  P3 button for the current minute setting. The numbers will flash. Use  P4 and  P6 to change numbers. After setting, save it with  P3. After the time setting is completed,  P4 button changes to day / month / year. Press  P3 to enter. The display will flash. Use  P4 and  P6 to change numbers. Press  P3 to set the time according to the order in the setup menu. Use P1 ESC to exit.

5.2.7. LANGUAGE MENU

Press the P3 button to enter the submenu. The  P4 and  P6 buttons are the preferred language. Sample; Turkish  P3 button to save. Use P1 ESC to exit.

5.2.8. ENTRANCE MENU

Press the P3 button to enter the submenu. The following screen will appear

Contrast	Used to adjust the screen sharpness.
Minimum Light	Used to adjust the display illumination
Login Address	Not used
Network List	Not used
Acoustic Alarm	Not used

5.2.9. SYSTEM (PARAMETERS) MENU

FOR AUTHORIZED SERVICE.

OUR COMPANY IS NOT RESPONSIBLE FOR ANY DAMAGES IN CASE USER ENTERS IN SYSTEM MENU AND CHANGE THE PARAMETERS

6. CLEANING AND MAINTENANCE

TP-16 / TP- 24 / TP-28 / TP-25

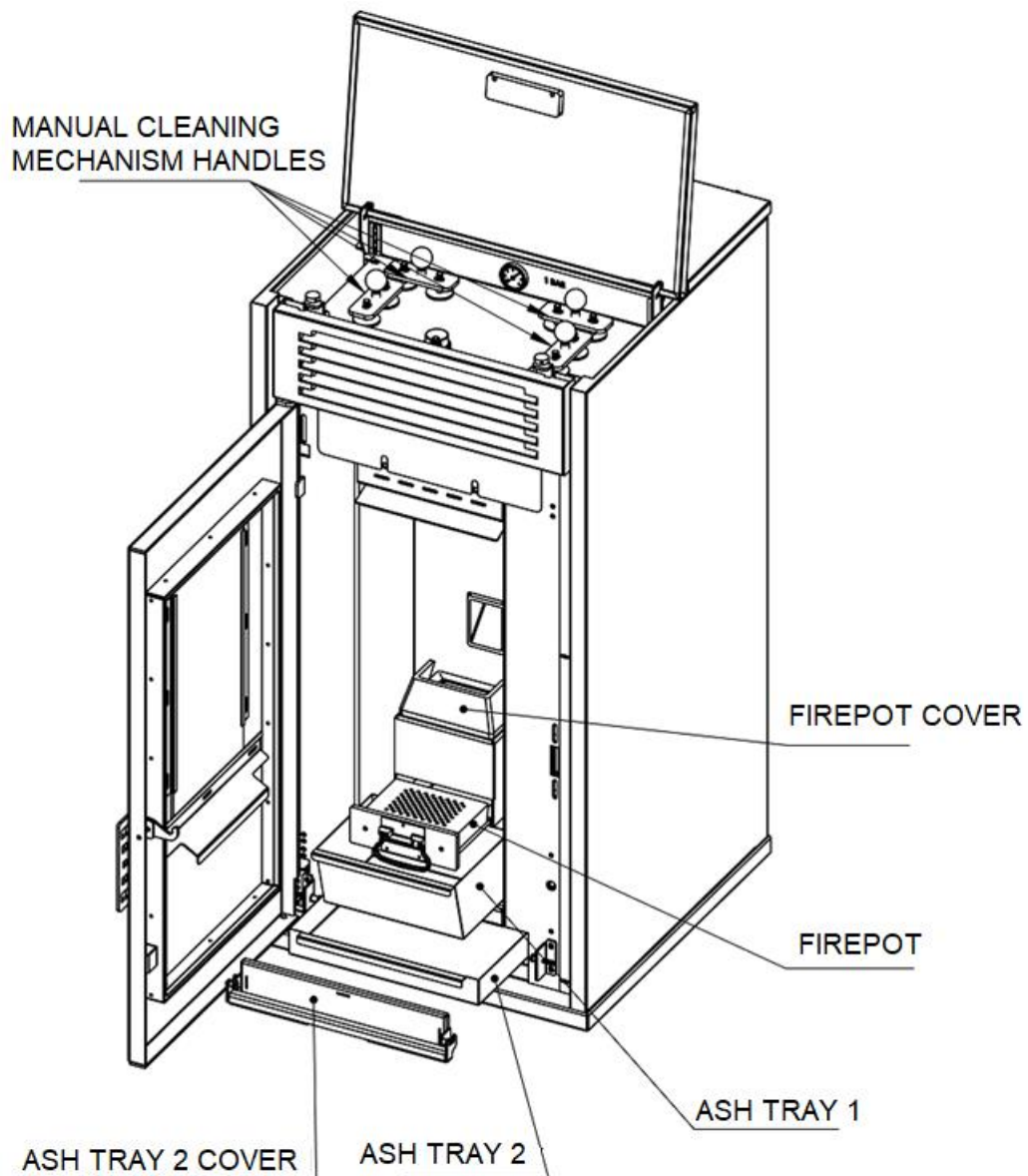

TP-30

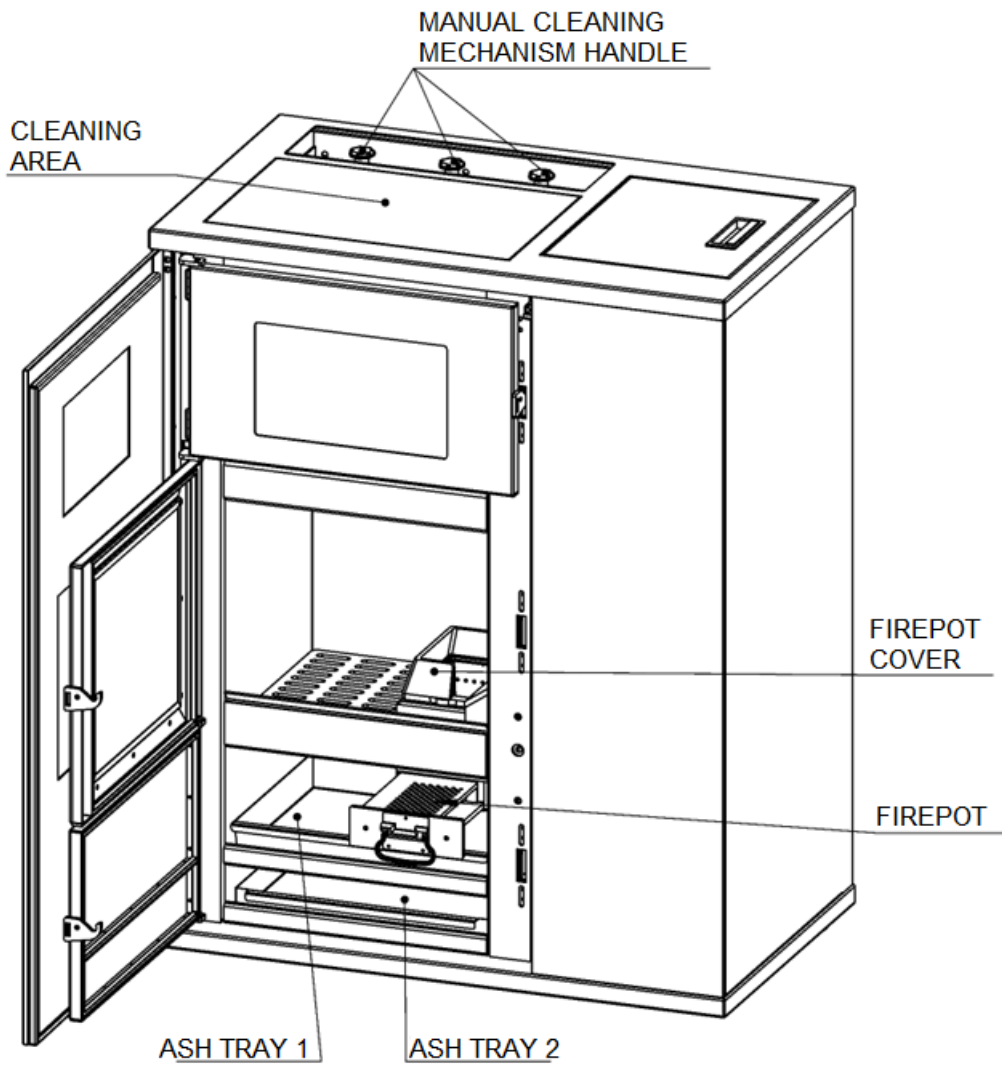

DP-35

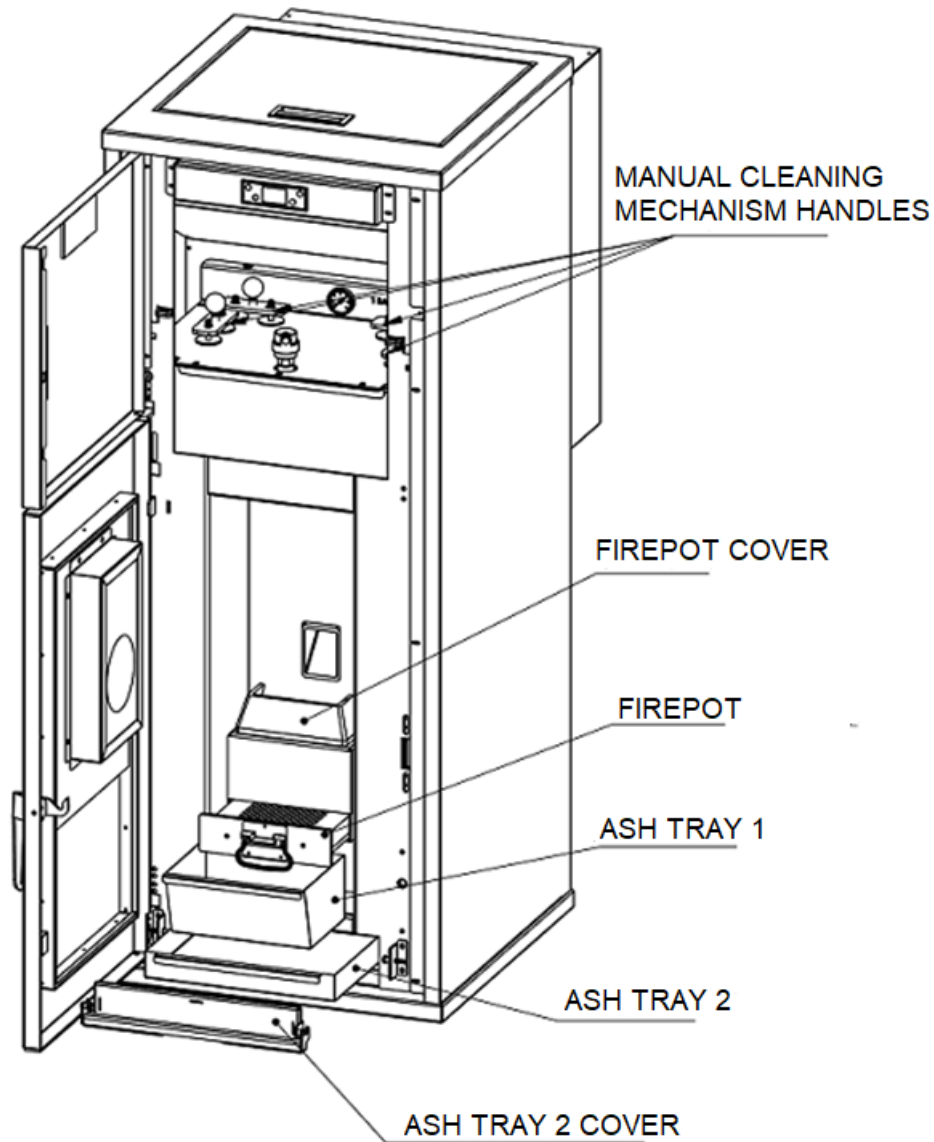

Sections to clean	Cleaning Frequency
Flame Transmission Pipes Cleaning	Daily (Through moving manual cleaning mechanism handle 4-5 times)
Firepot Cleaning	Daily
Ash tray 1 Cleaning	Daily
Ash tray 2 Cleaning	Once 10 days
Flue Pipes Cleaning	Once a month
Chimney Cleaning	Twice a year

6.1 FLAME PIPES CLEANING

TP-16 / TP- 24 / TP-28 / TP-25

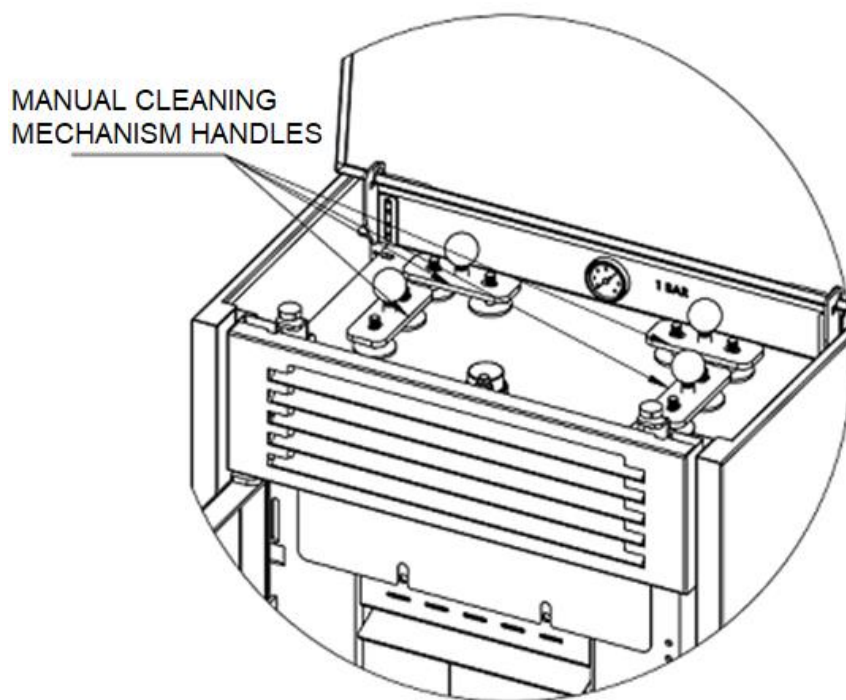

TP-30

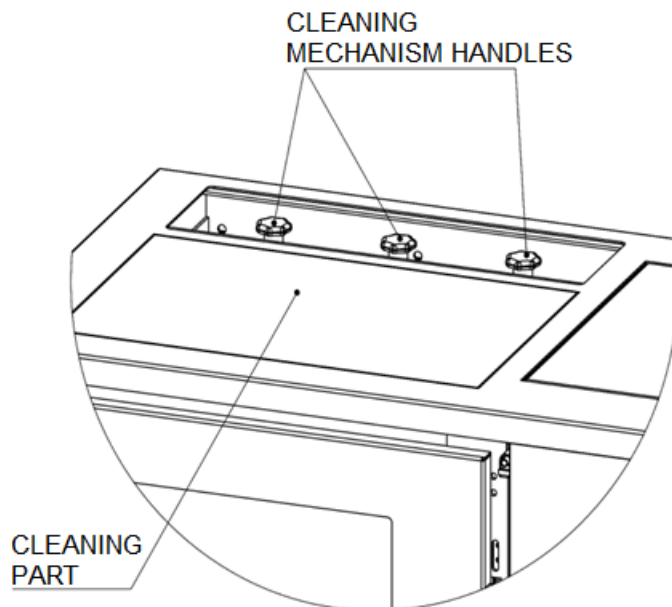

TP-35

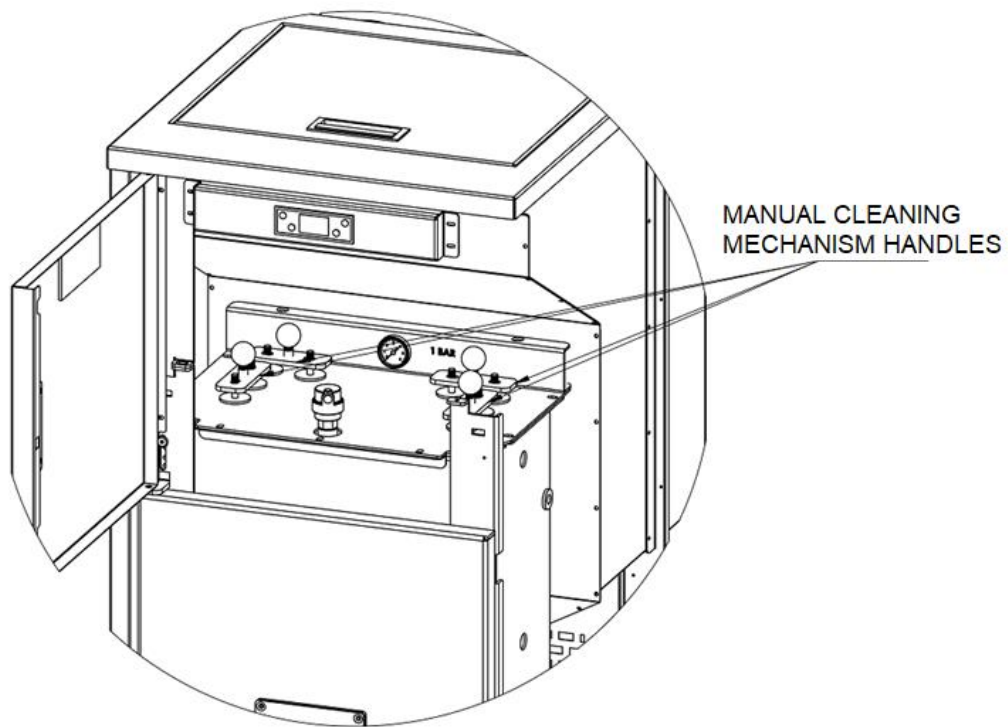

For the cleaning of the flame transmission pipes, manual cleaning mechanism handles will be used. These handles are placed under the top plate for TP-16, TP-24, TP-30 AND TP-25 models, also placed inside the top cover for TP-35 model. Cleaning frequency must be daily and by removing the handles for 4-5 times.

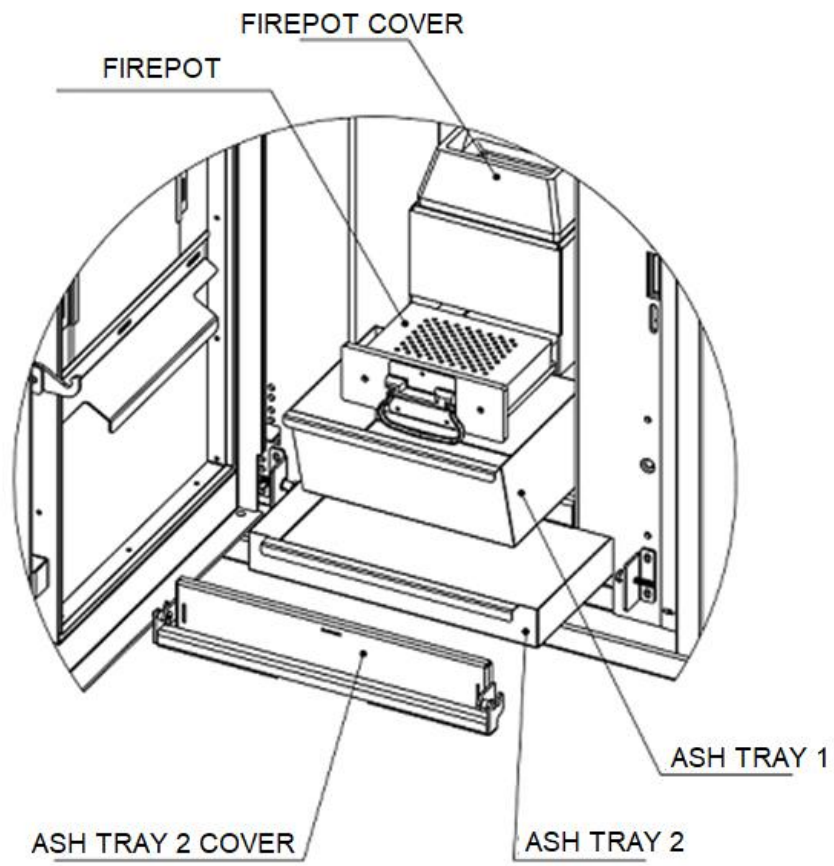

TP-30

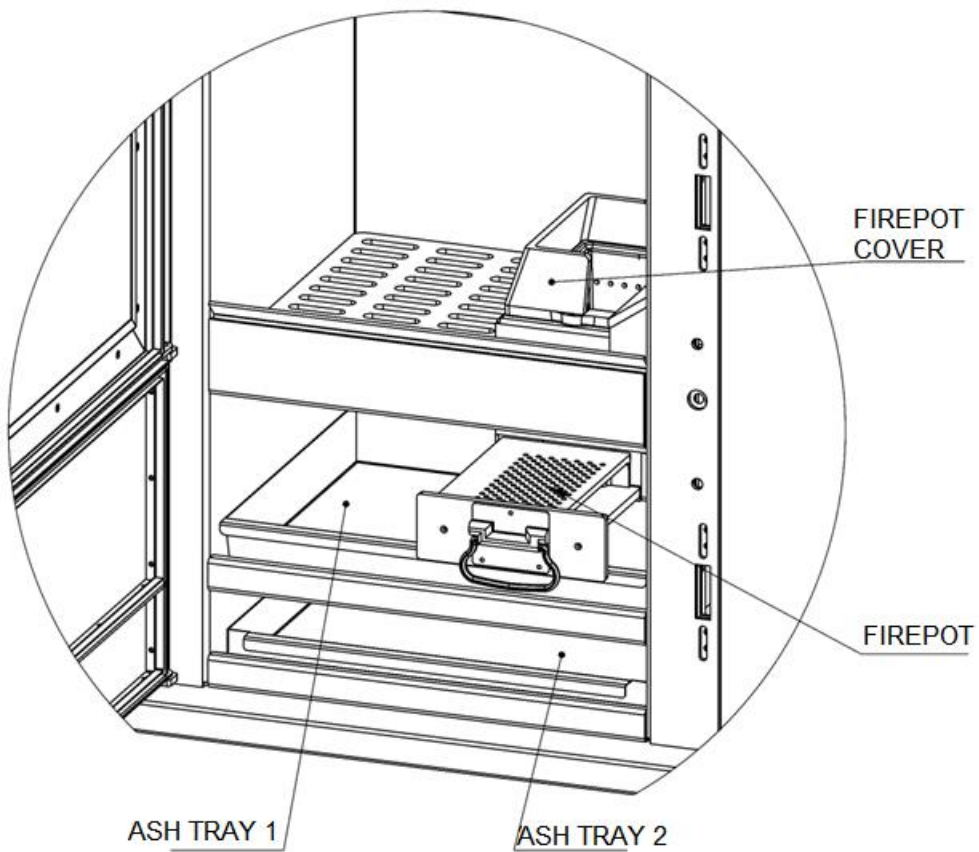

6.2. COMBUSTION POT CLEANING

The firepot which is used on our products is easy-to-replace. When you pull it, it will be moved out easily. You should clean it daily.

6.3 ASH TRAY 1 AND ASH TRAY 2 CLEANING

The ashtray 1 and ashtray 2 which is placed under the firepot is easy-to-replace. When you pull them, they will be moved out easily. You should clean ash tray 1 daily, ash tray 2 once in 10 days.

7. GENERAL WARRANTY AND POLICIES

ARAL MAKİNA MADENİ EŞYA SAN. VE TİC.LTD. ŞTİ provides warranty to the buyer within the framework of legal provisions. 2 (two) year warranty period starts from the actual delivery date. An invoice must be presented for inclusion in the warranty.

In case of any damage related to production in our product, our company will try to repair this damage as soon as possible within the warranty period or it will replace the problematic part. Only spare parts approved or supplied by the manufacturer must be used.

After the warranty period, our company will continue to serve you in the necessary conditions.

You are kindly requested to inform the relevant dealer where you have purchased the product from with the model number printed on the label on the back of the product.

The company reserves the right to make changes to the product after publication of this manual.

Malfunctions resulting from the use of the product contrary to the matters stated in the user manual are not covered by the warranty

Pump, glass, cast irons, electric current high/low voltage resulted to a digital card failure, user errors are not covered by the warranty.

Our company is not responsible for any damages during transport, in case dealer or manufacturer are not informed about it and not presented the proof.

The problems can be occurred in case antifreeze are not used, are not covered by the warranty.

Our company is not responsible for damages caused by running without water.

Our company is not responsible for any damage that may occur in case of any voltage drop or rise.

The damages can be occurred related to sanitary are not covered by the warranty.

Our company is not responsible for any damages in case user enters in system menu and change the parameters.

The damages can be occurred in case cleaning and maintenance are not made are not covered by the warranty.

PRODUCER

AUTHORIZED

<p>Company Name : Aral Makina Madeni Eşya San. Ve Tic.Ltd. Şti Address : Organize Sanayi Bölgesi 8.Cad. No: 16 Melikgazi / KAYSERİ Tel : +90 0 352 321 28 11 Fax : +90 0 352 321 28 14 E- posta : aral@aralmakina.com.tr</p> <p>Sign / Stamp</p>	<p>Company Name Address : Tel : Fax : E- posta : Sign / Stamp</p>
--	--

User Informations	
Name – Surname	
Address	
Tel	
E-posta	

Model	
Barkod / Seri No	
Warranty	2 Years
Starting Date of Warranty	